

BALKAN CHAMPIONSHIP U15

Niksic (MNE), 07-08 Jul 2018

-34 kg

9 Judoka

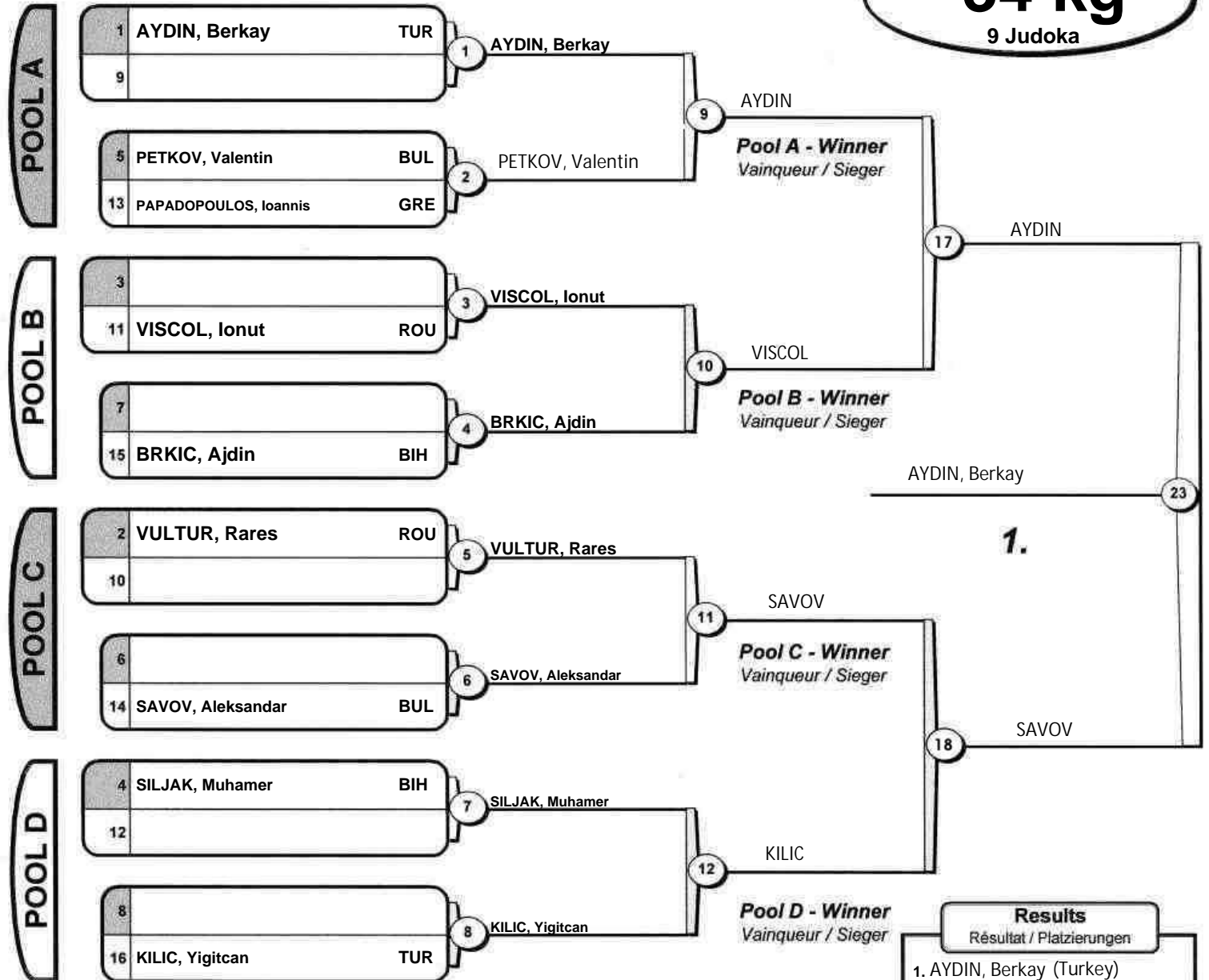

- Results**
Résultat / Platzierungen
1. AYDIN, Berkay (Turkey)
 2. SAVOV, Aleksandar (Bulgaria)
 3. PETKOV Valentin (Bulgaria)
 3. VISCOL Ionut (Romania)
 5. KILIC Yigitcan (Turkey)
 5. VULTUR Rares (Romania)
 7. BRKIC Ajdin (Bosnia&Herzegovina)
 7. Siljak Muhamer (Bosnia&Herzegovina)

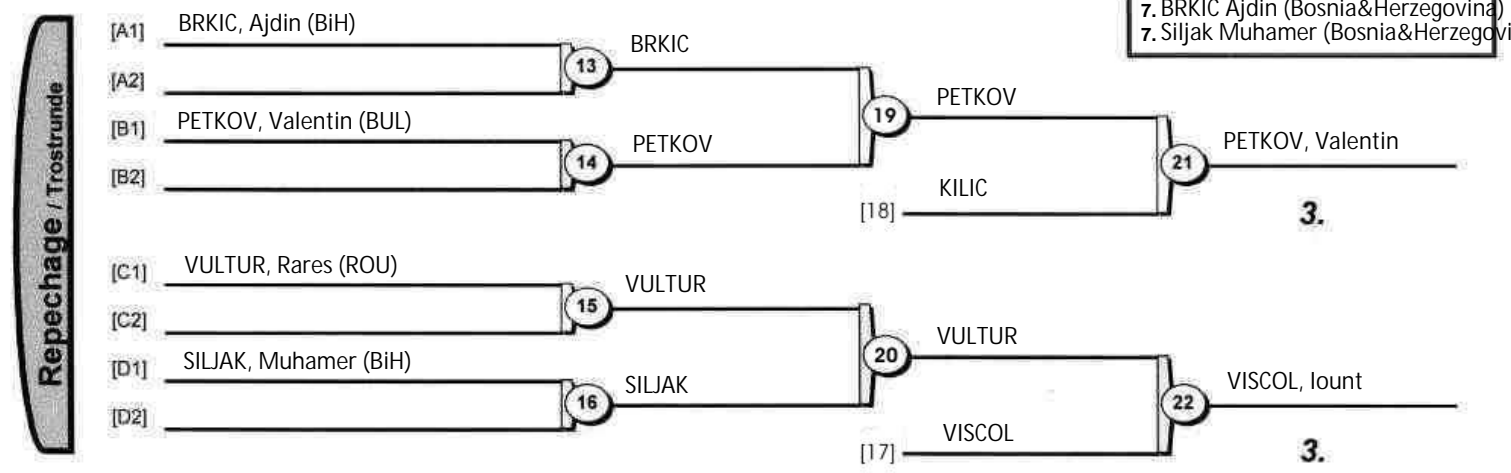

BALKAN CHAMPIONSHIP U15

Niksic (MNE), 07-08 Jul 2018

-38 kg

10 Judoka

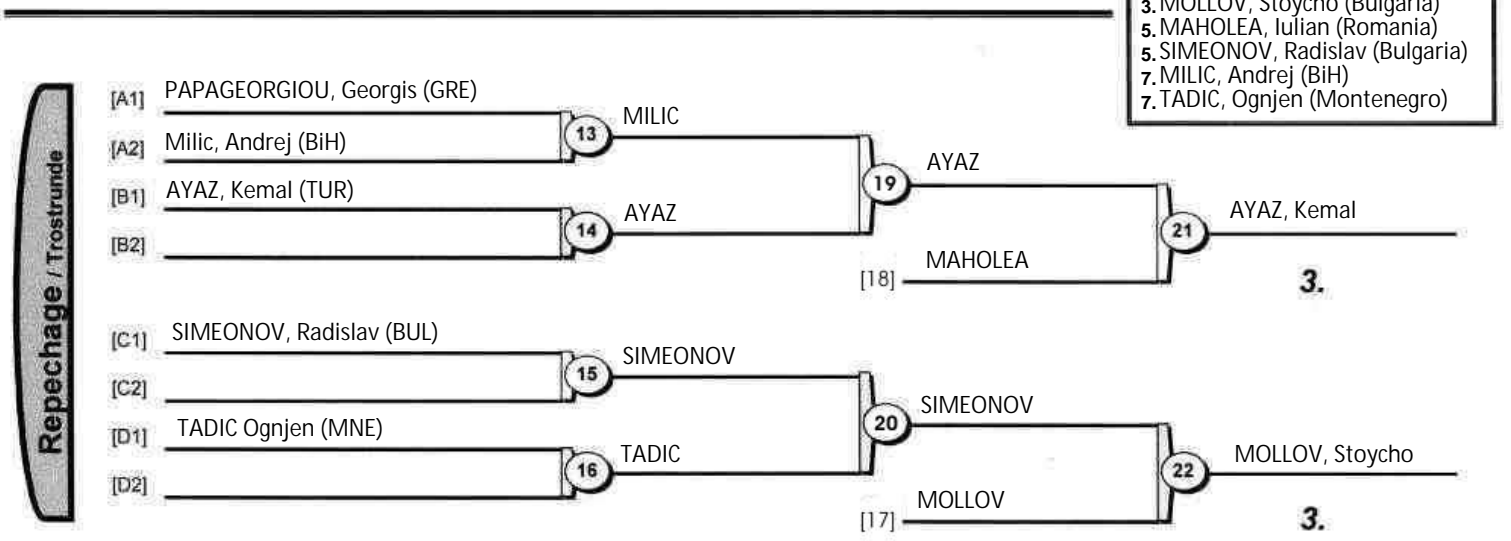
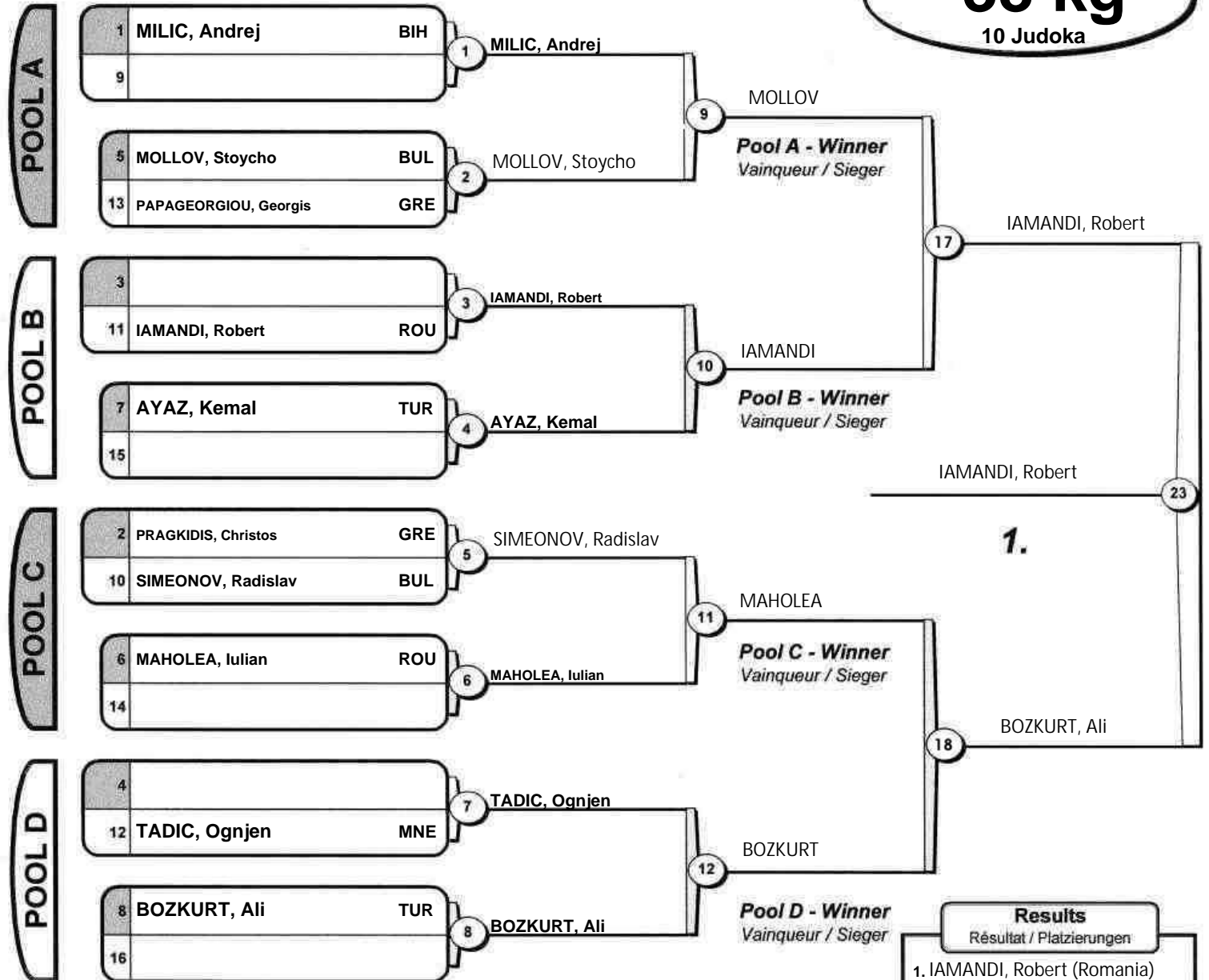

BALKAN CHAMPIONSHIP U15

Niksic (MNE), 07-08 Jul 2018

-42 kg

11 Judoka

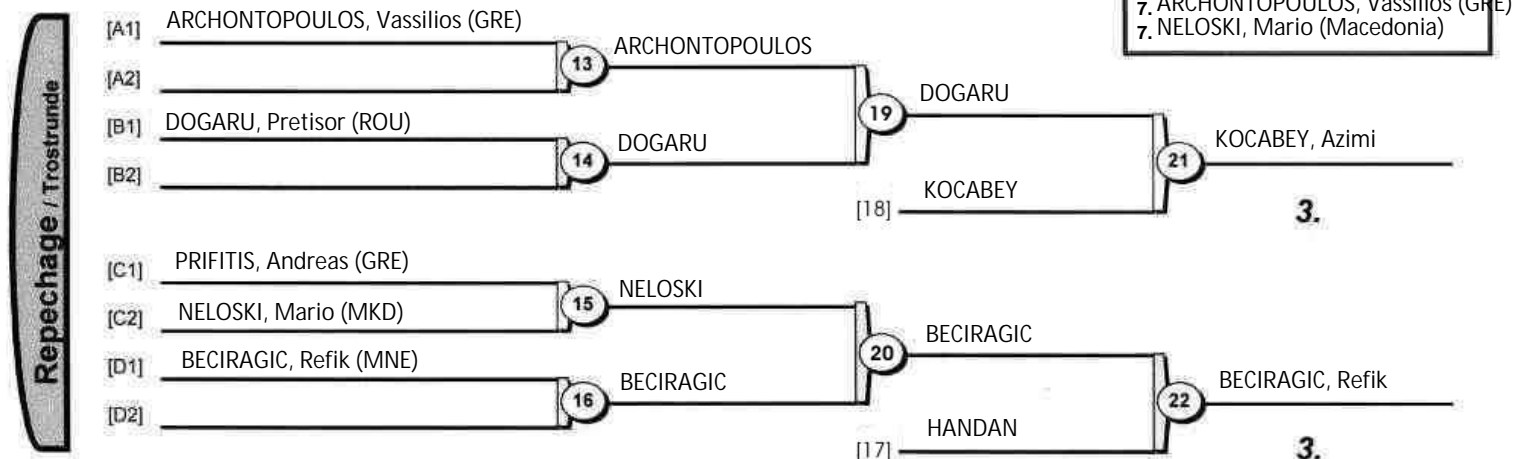
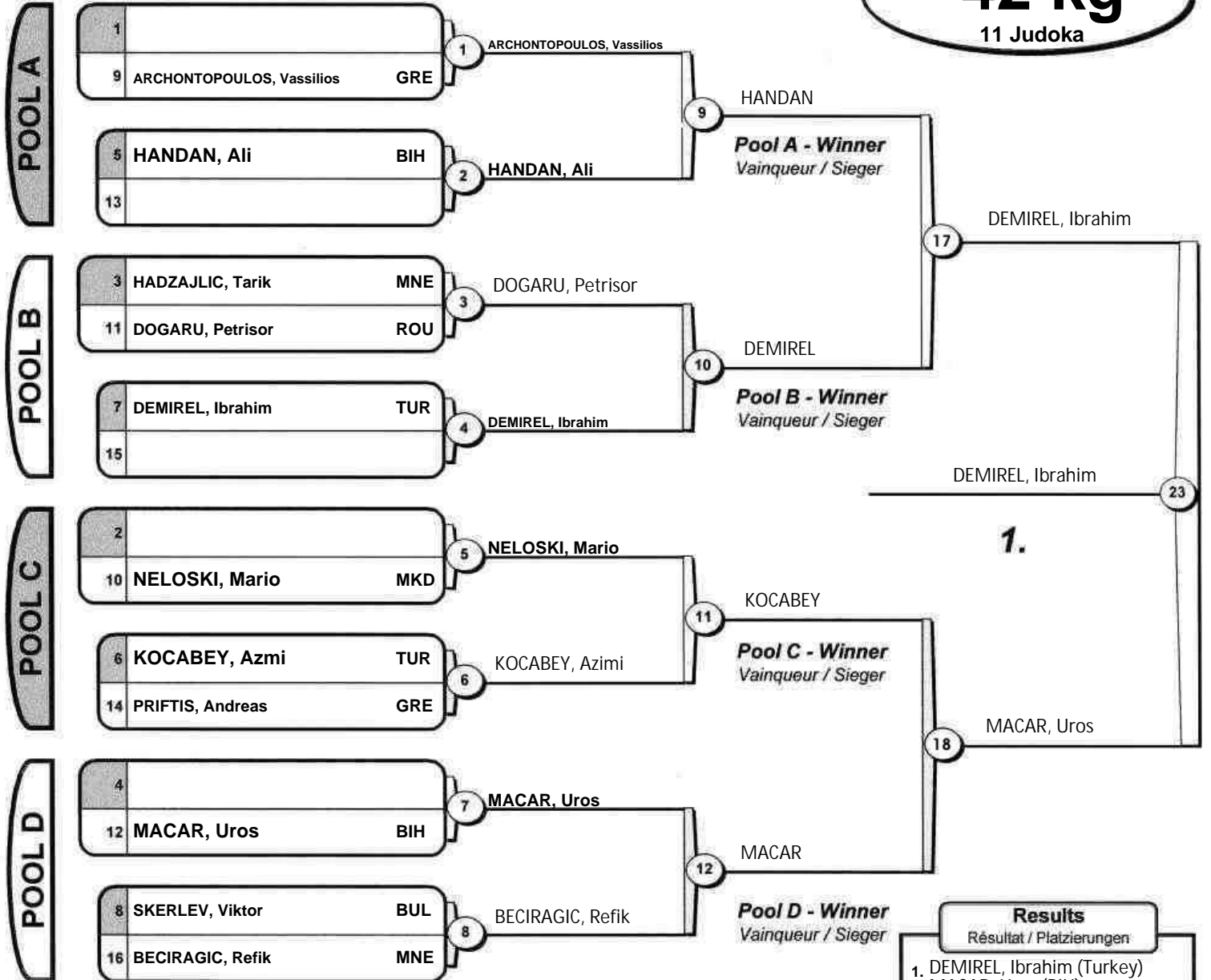

BALKAN CHAMPIONSHIP U15

Niksic (MNE), 07-08 Jul 2018

-46 kg

12 Judoka

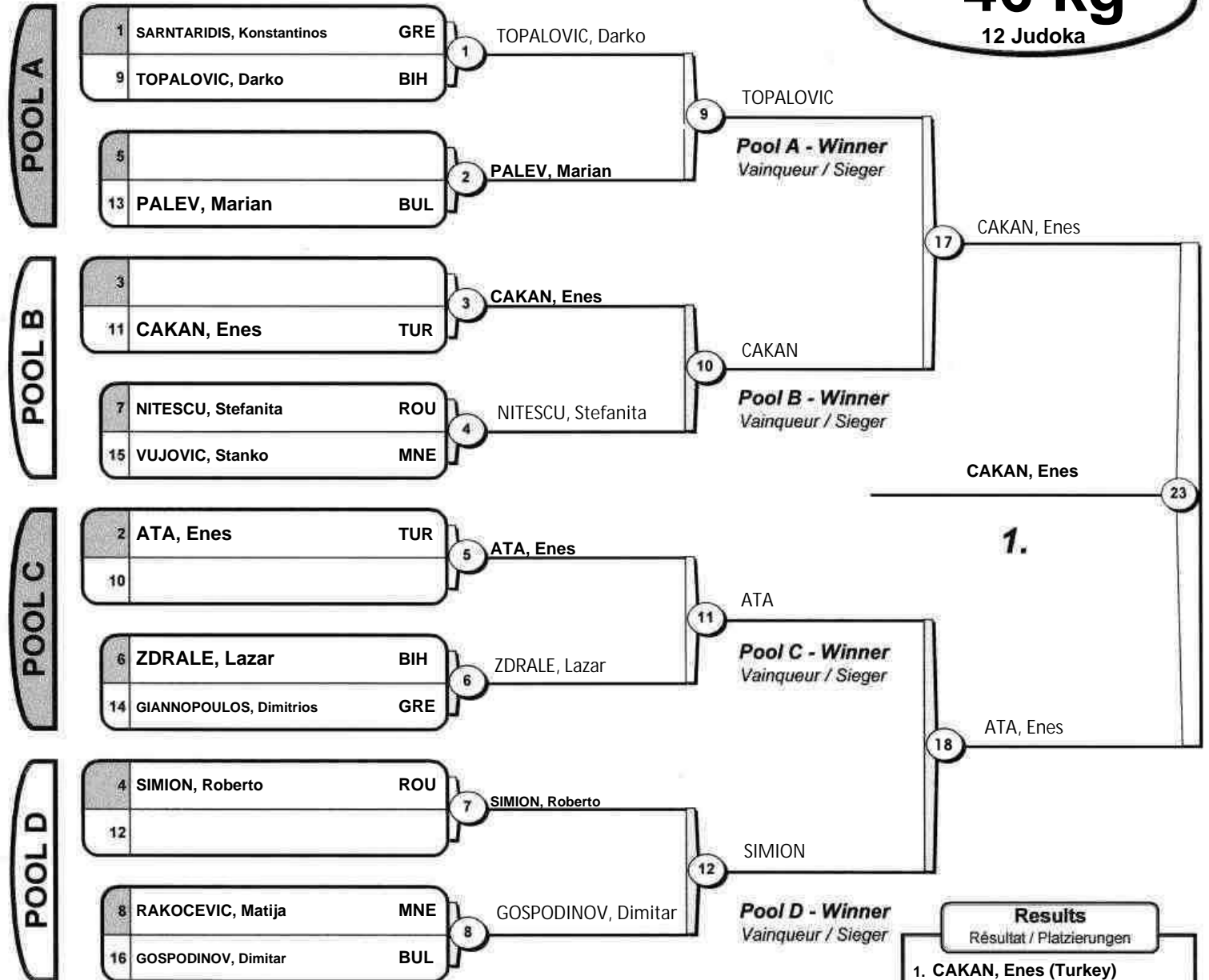

- | Results | |
|--------------------------|--------------------------------|
| Résultat / Platzierungen | |
| 1. | CAKAN, Enes (Turkey) |
| 2. | ATA, Enes (Turkey) |
| 3. | NITESCU, Stefanita (Romania) |
| 3. | GOSPODINOV, Dimitar (Bulgaria) |
| 5. | SIMION, Roberto (Romania) |
| 5. | PALEV Marian (Bulgaria) |
| 7. | TOPALOVIC, Darko (BiH) |
| 7. | ZDRALE, Lazar (BiH) |

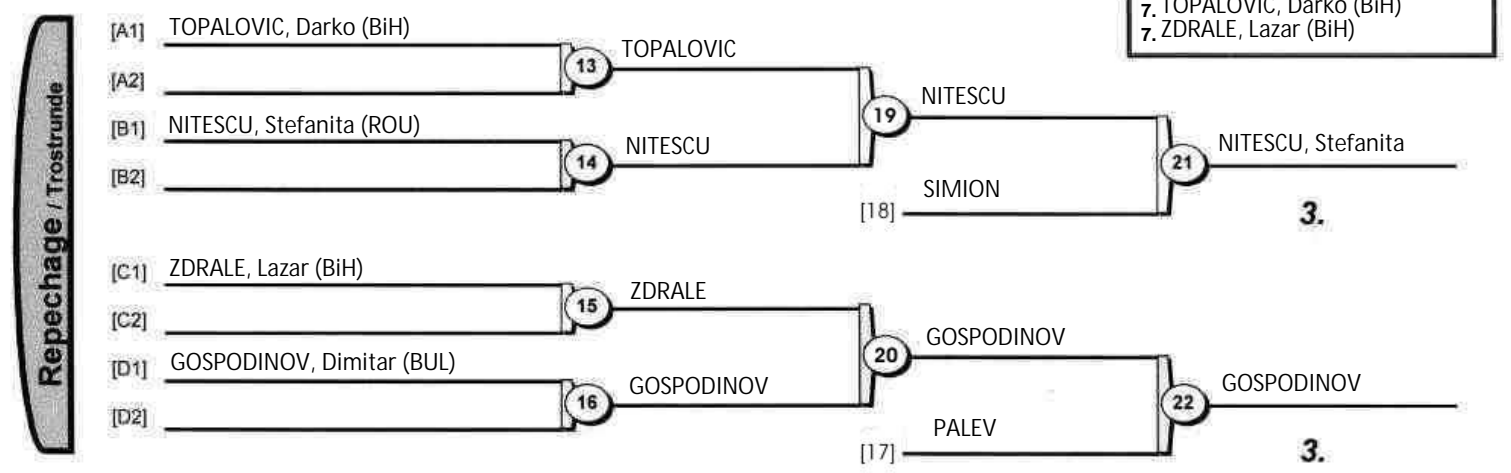

BALKAN CHAMPIONSHIP U15

Niksic (MNE), 07-08 Jul 2018

-50 kg

13 Judoka

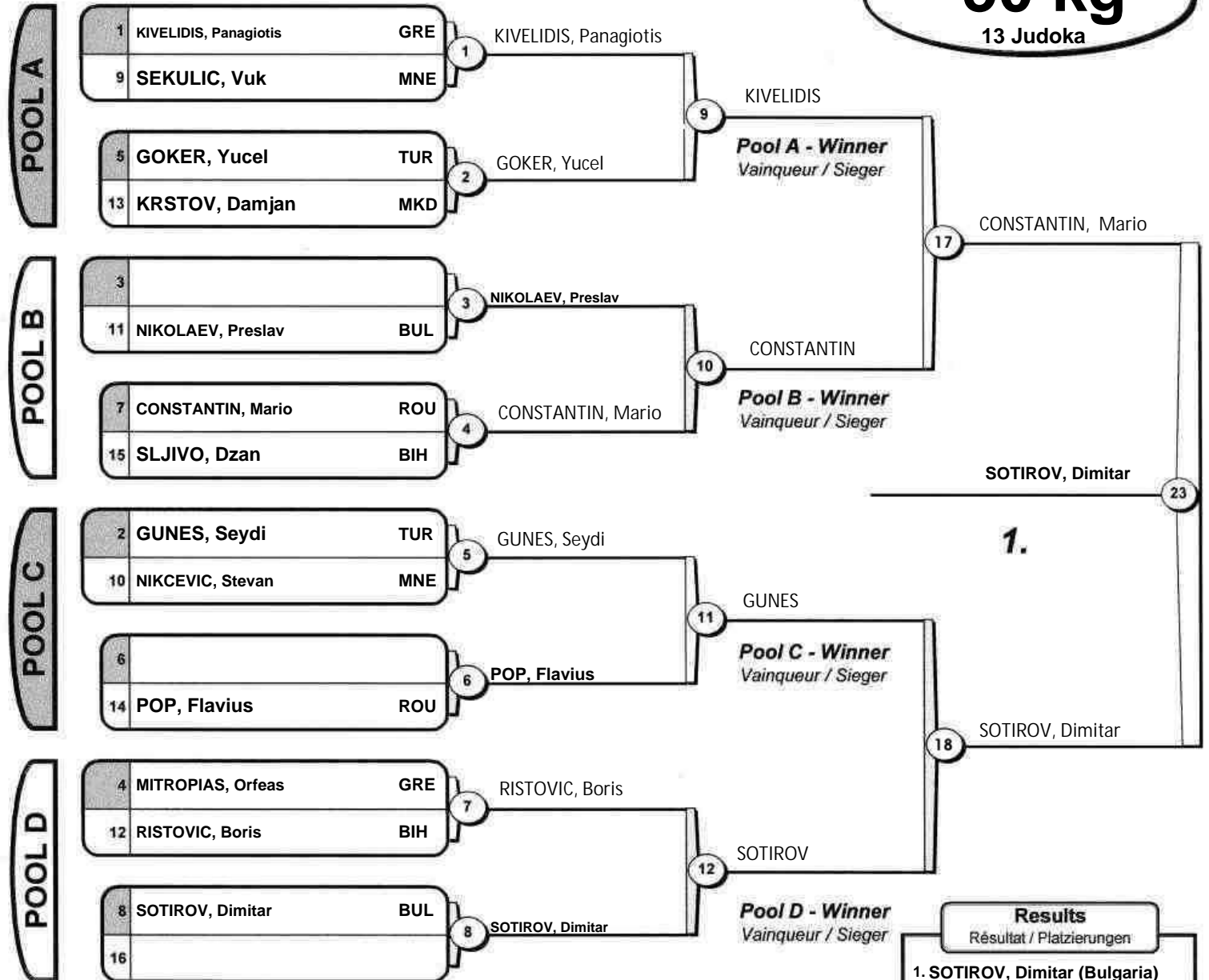

- Results**
Résultat / Platzierungen
1. SOTIROV, Dimitar (Bulgaria)
 2. CONSTANTIN, Mario (Romania)
 3. GOKER, Yucel (Turkey)
 3. RISTOVIC, Boris (BiH)
 5. GUNES, Seydi (Turkey)
 5. KIVELIDIS, Panagiotis (Greece)
 7. SLJIVO, Dzan (BiH)
 7. NIKCEVIC, Stevan (Montenegro)

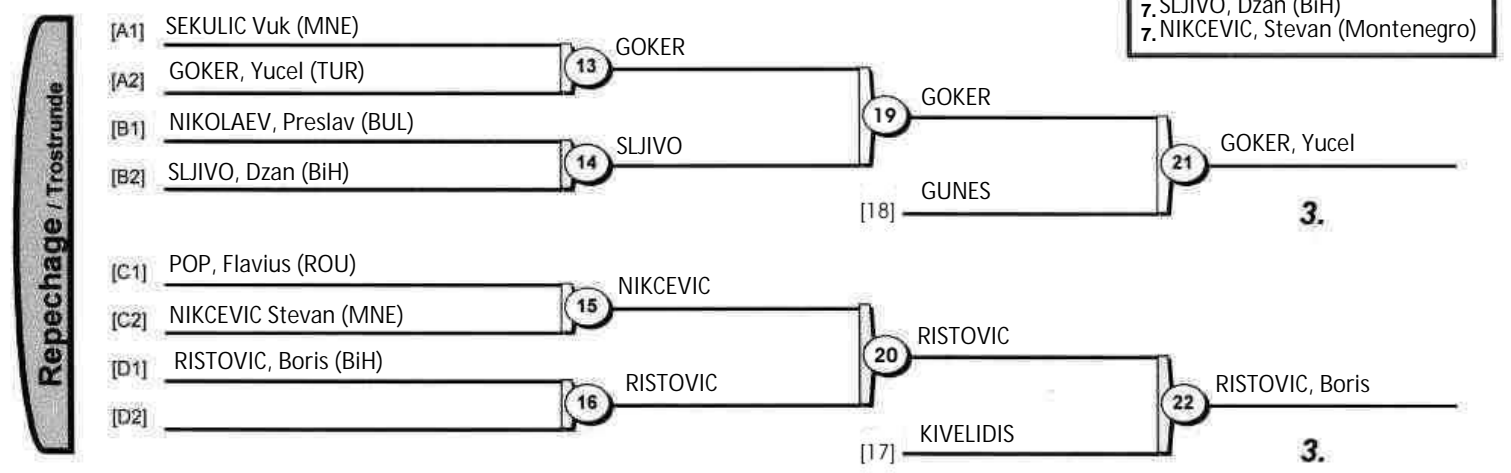

BALKAN CHAMPIONSHIP U15

Niksic (MNE), 07-08 Jul 2018

-55 kg

10 Judoka

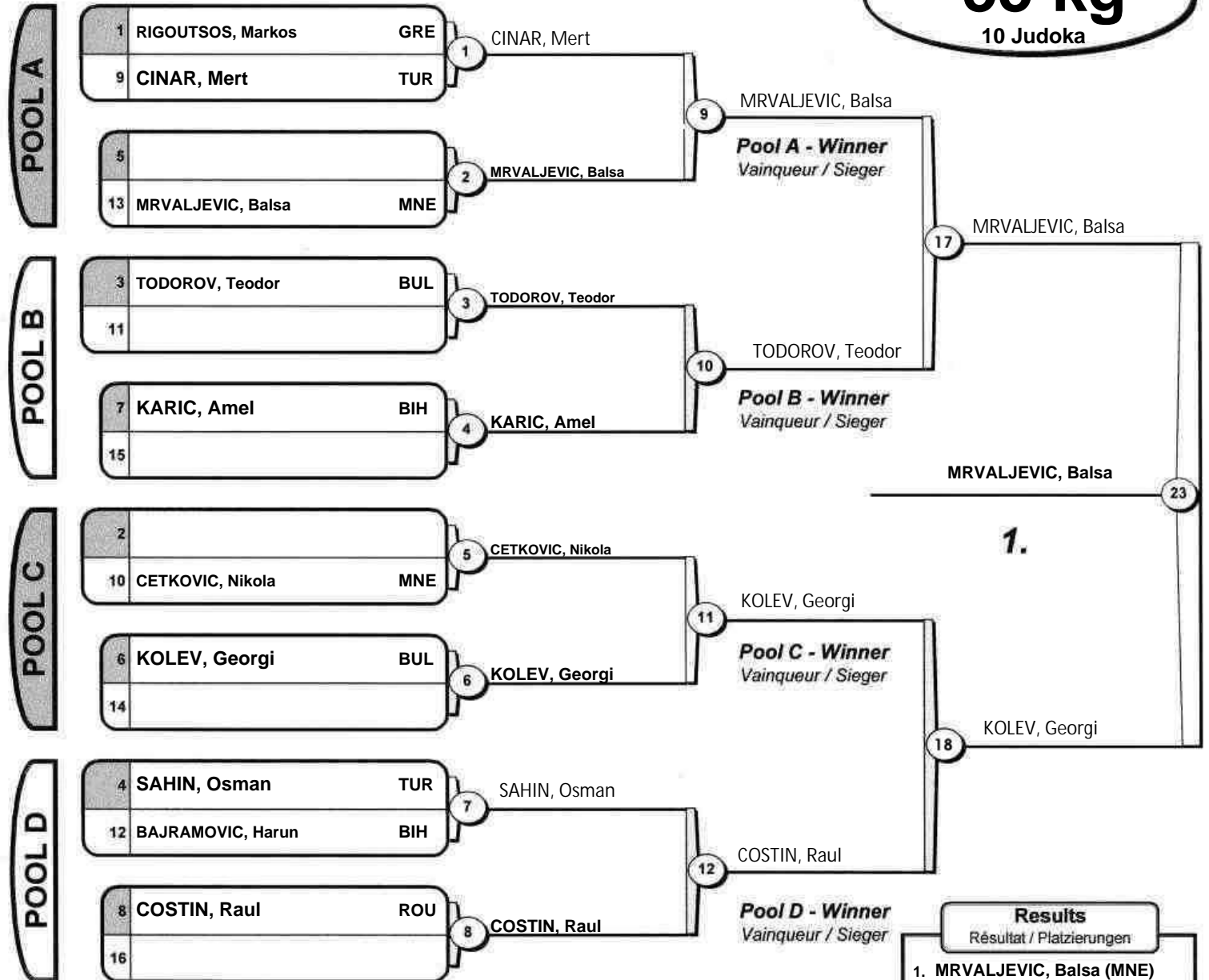

- Results**
Résultat / Platzierungen
- MRVALJEVIC, Balsa (MNE)
 - KOLEV, Georgi (Bulgaria)
 - COSTIN, Raul (Romania)
 - TODOROV, Teodor (Bulgaria)
 - CINAR, Mert (Turkey)
 - SAHIN, Osman (Turkey)
 - KARIC, Amel (BiH)
 - CETKOVIC, Nikola (Montenegro)

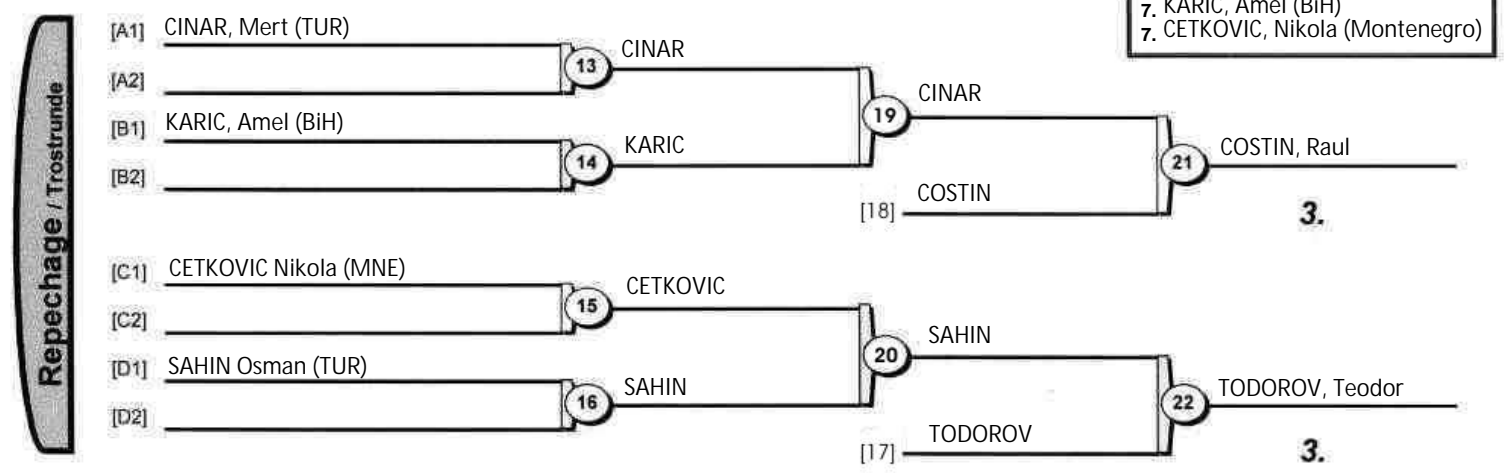

BALKAN CHAMPIONSHIP U15

Niksic (MNE), 07-08 Jul 2018

-60 kg

10 Judoka

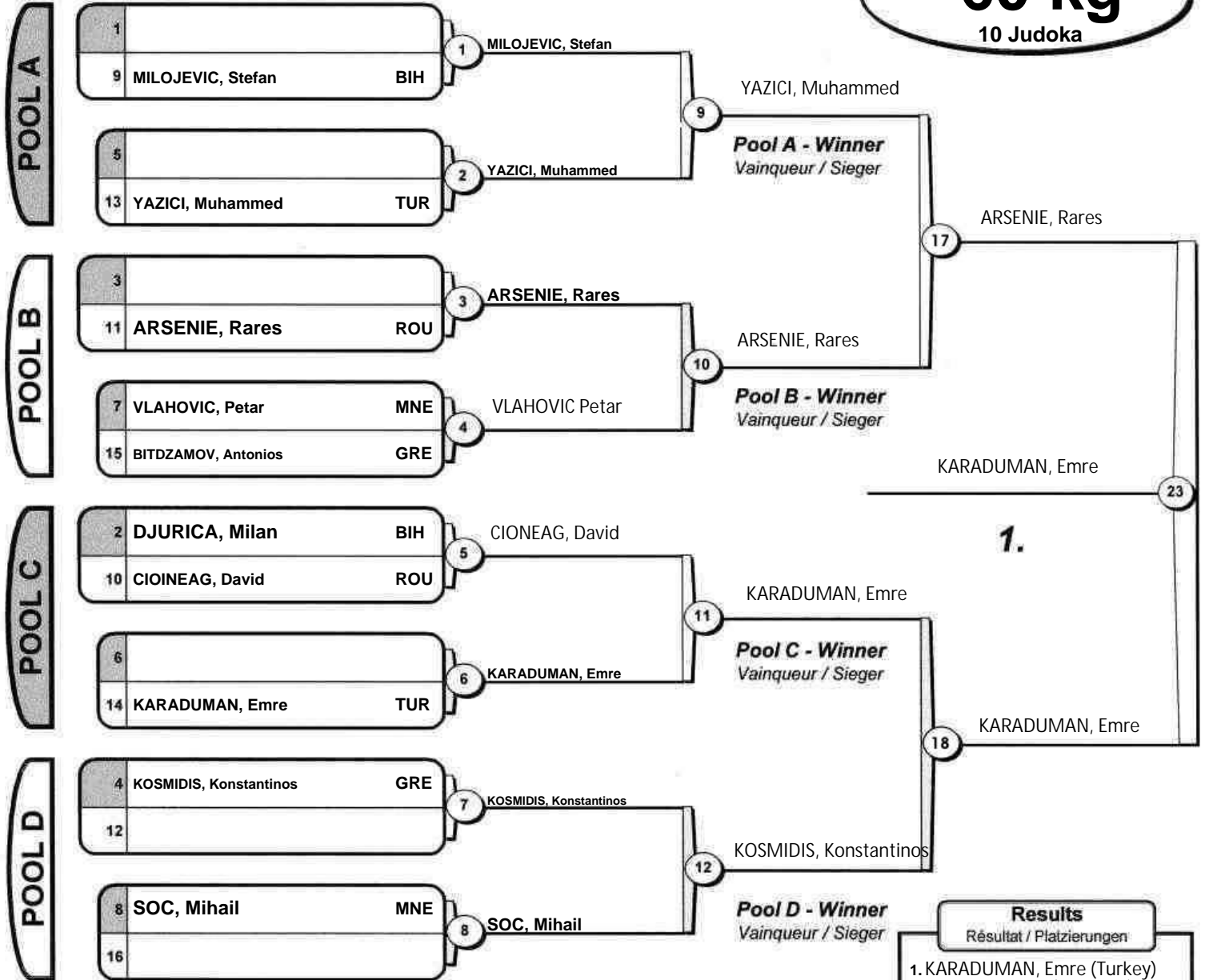

Results	
Résultat / Platzierungen	
1.	KARADUMAN, Emre (Turkey)
2.	ARSENIE, Rares (Romania)
3.	KOSMIDIS, Konstantinos (GRE)
3.	YAZICI, Muhammed (Turkey)
5.	MILOJEVIC, Stefan (BIH)
5.	CIOINEAG, David (Romania)
7.	VLAHOVIC, Petar (Montenegro)
7.	SOC, Mihail (Montenegro)

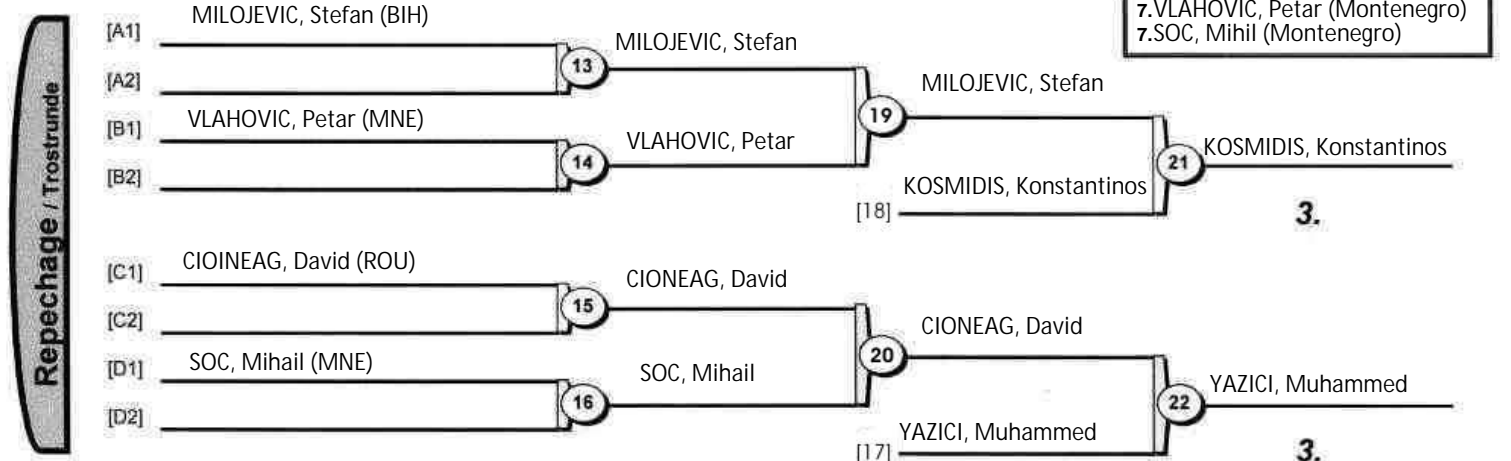

BALKAN CHAMPIONSHIP U15

Niksic (MNE), 07-08 Jul 2018

-66 kg

12 Judoka

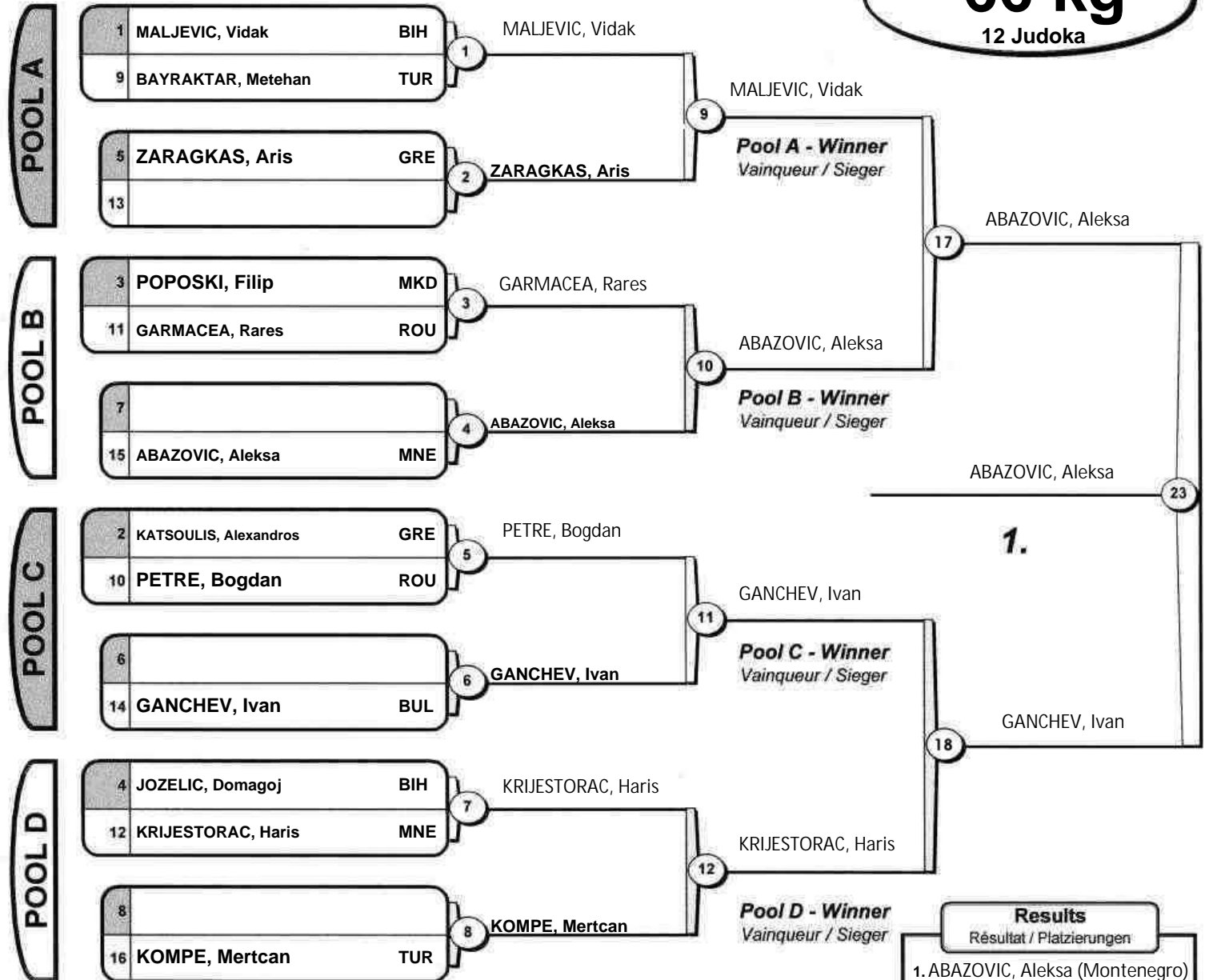

- Results**
 Résultat / Platzierungen
1. ABAZOVIC, Aleksa (Montenegro)
 2. GANCHEV, Ivan (Bulgaria)
 3. BAYRAKTAR, Metehan (TUR)
 3. MALJEVIC, Vidak (BIH)
 5. KRIJESTORAC, Haris (MNE)
 5. PETRE, Bogdan (Romania)
 7. GARMACEA, Rares (Romania)
 7. KOMPE, Mertcan (Turkey)

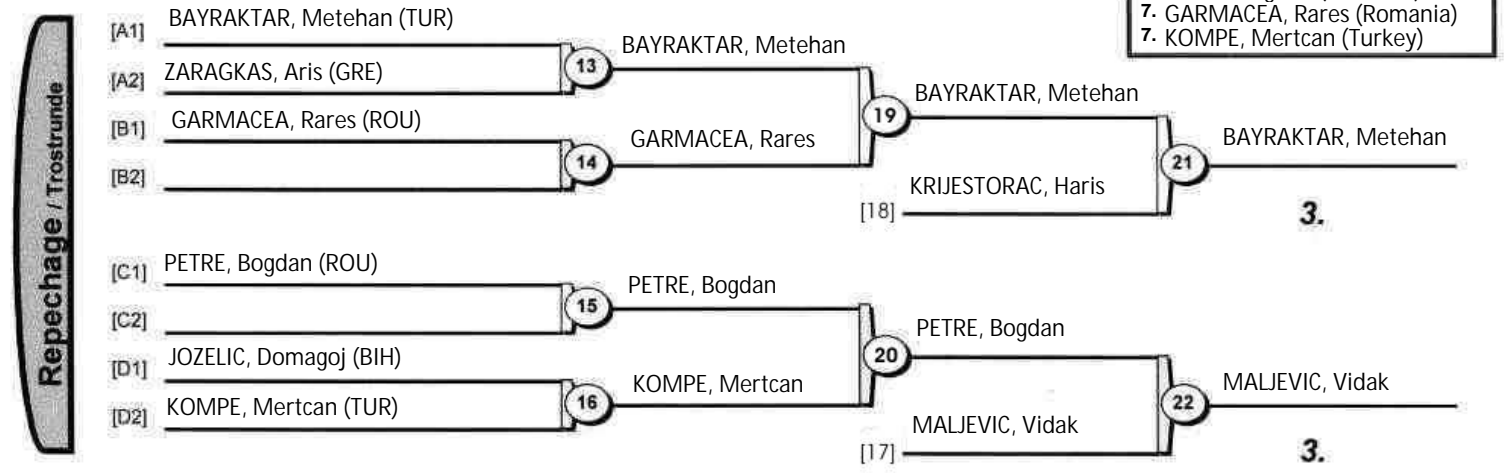

BALKAN CHAMPIONSHIP U15

Niksic (MNE), 07-08 Jul 2018

-73 kg

12 Judoka

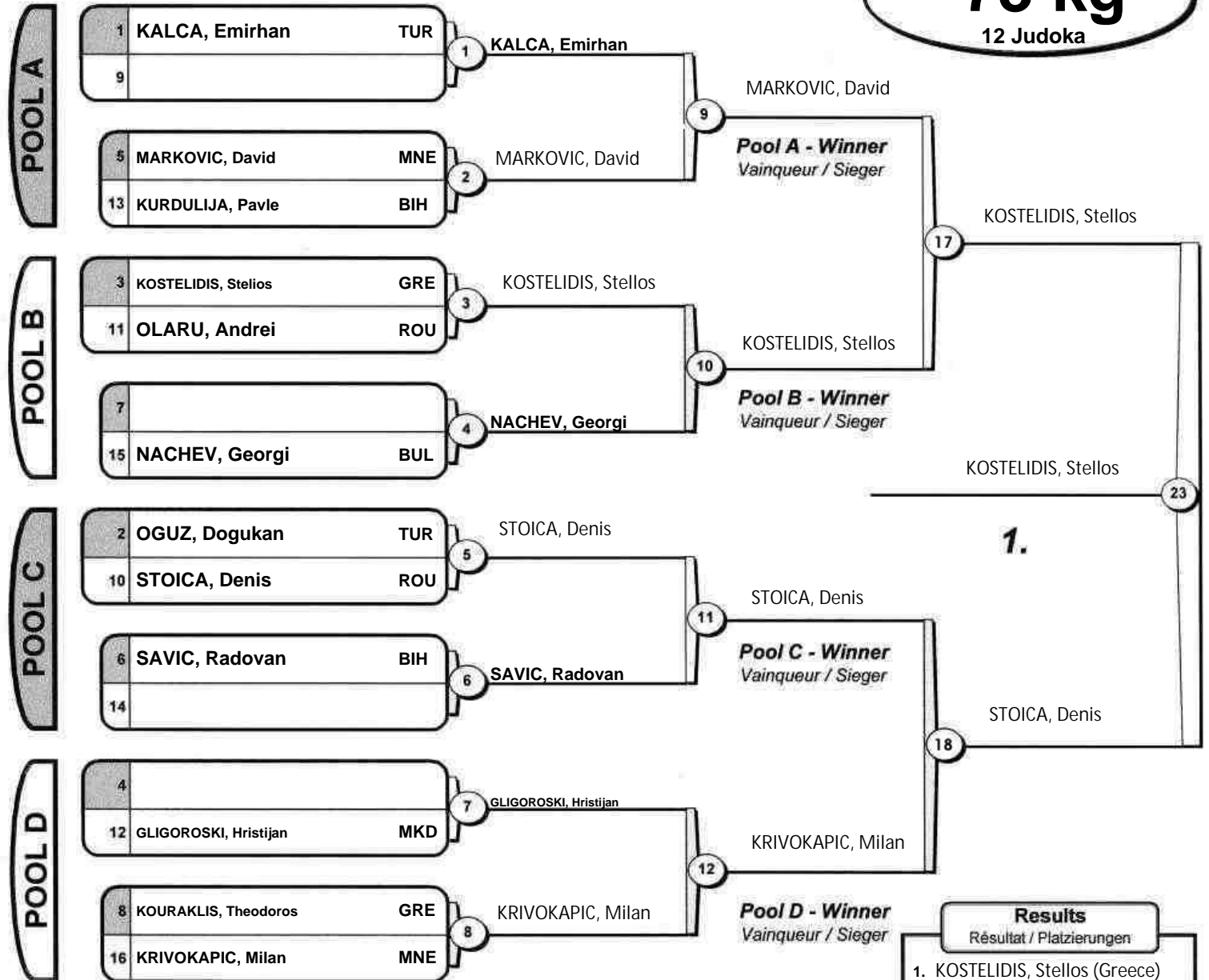

- Results**
Résultat / Platzierungen
- KOSTELIDIS, Stellos (Greece)
 - STOICA, Denis (Romania)
 - KRIVOKAPIC, Milan (MNE)
 - MARKOVIC, David (MNE)
 - OLARU, Andrei (ROM)
 - SAVIC, Radovan (BIH)
 - KURDULIJA, Pavle (BIH)
 - KOURAKLIS, Theodoros (GRE)

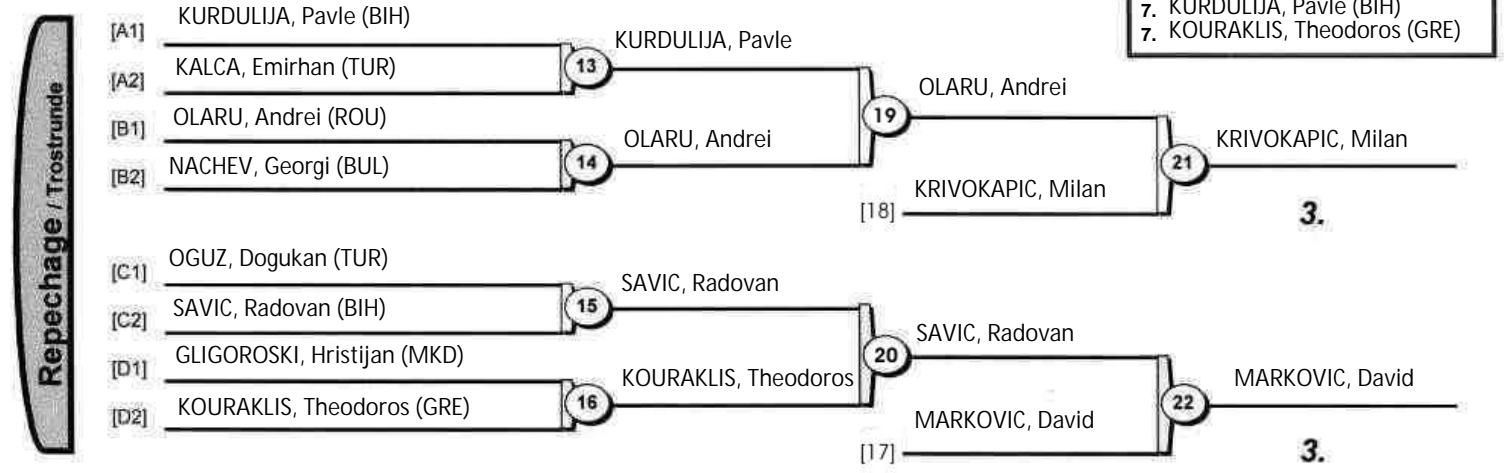

BALKAN CHAMPIONSHIP U15

Niksic (MNE), 07-08 Jul 2018

+73 kg

12 Judoka

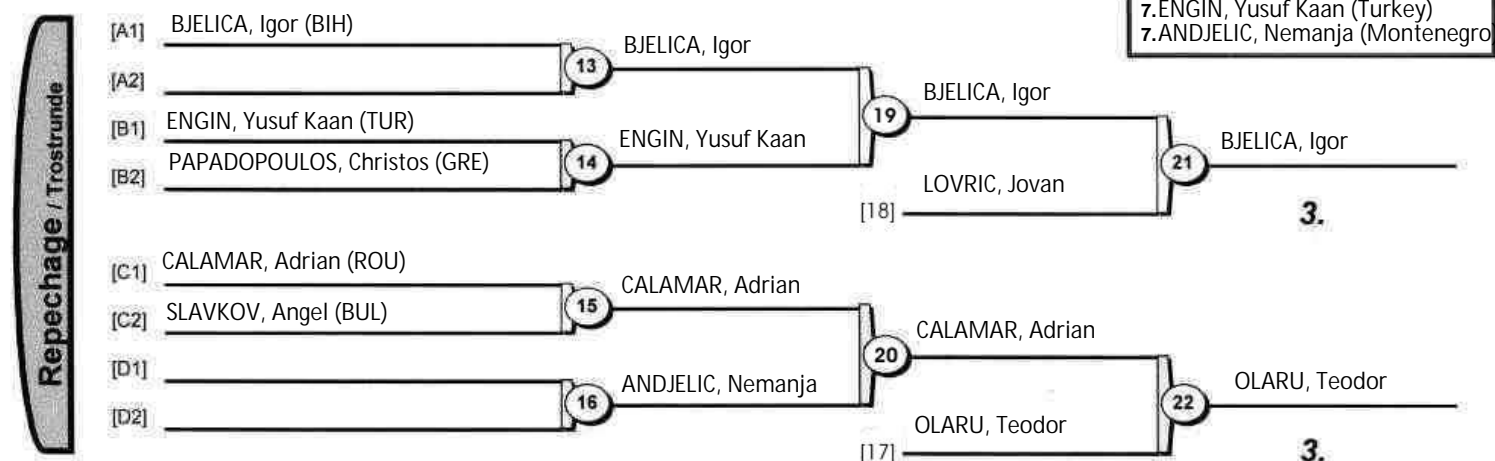
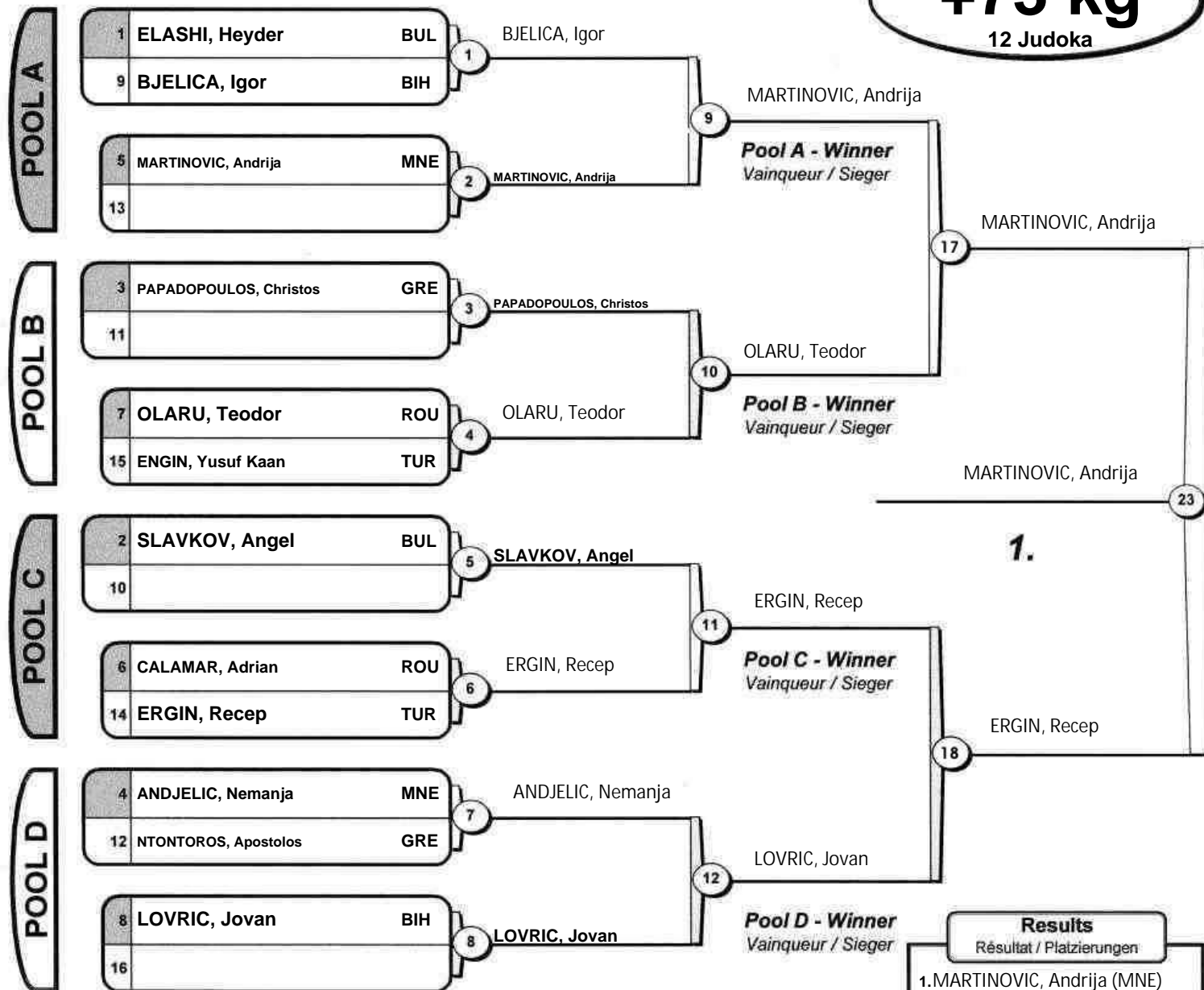

BALKAN CHAMPIONSHIP U15

Niksic (MNE), 07-08 Jul 2018

-32 kg

6 Judoka

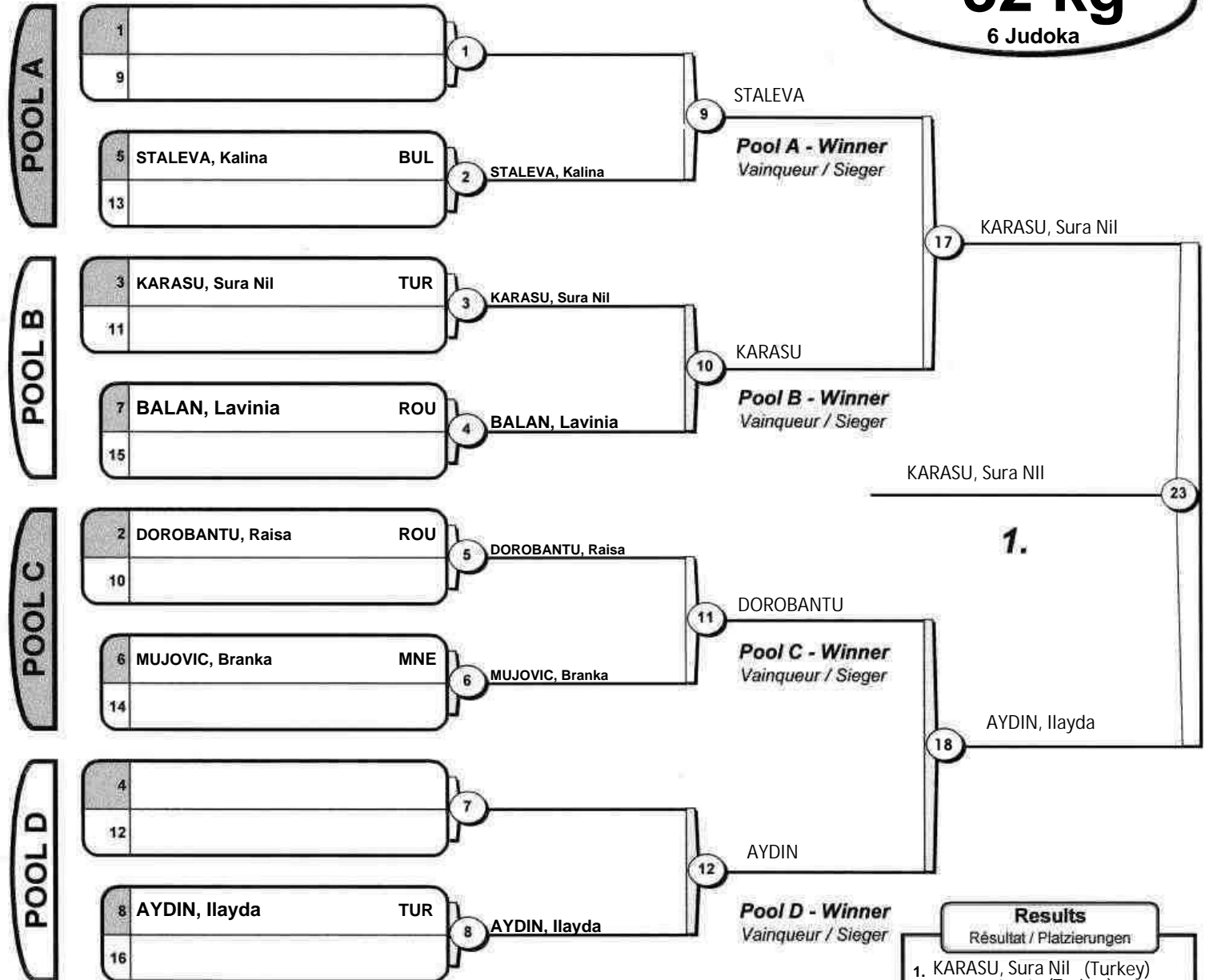

Results	
Résultat / Platzierungen	
1.	KARASU, Sura Nil (Turkey)
2.	AYDIN, Ilayda (Turkey)
3.	BALAN, Lavinia (Romania)
3.	STALEVA, Kalina (Bulgaria)
5.	DOROBANTU, Raisa (Romania)
7.	MUJOVIC, Branka (Montenegro)
7.	

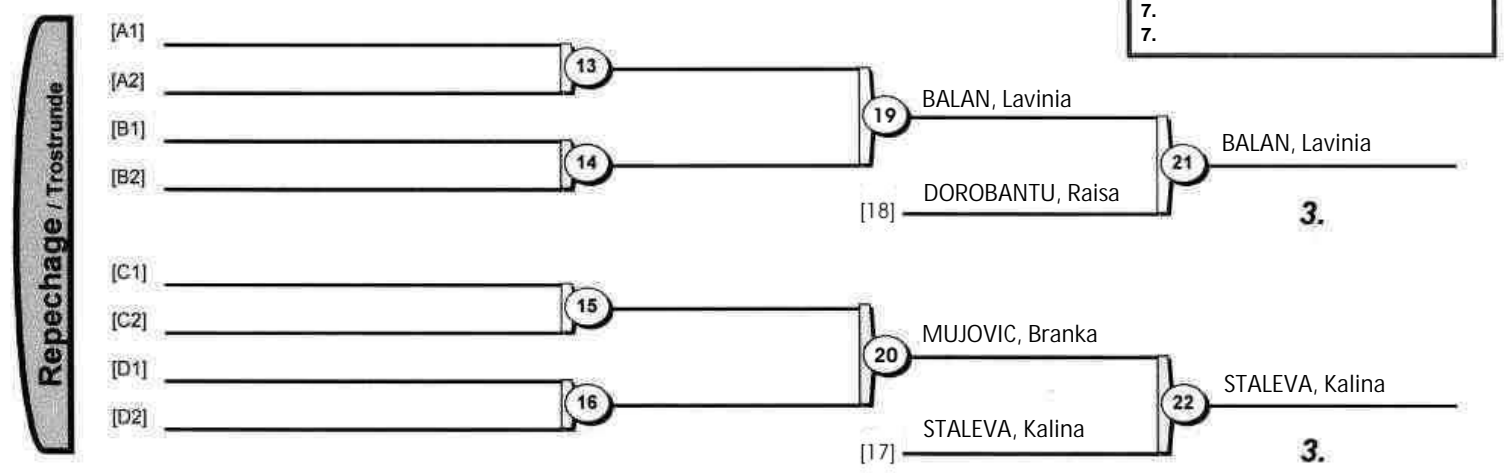

BALKAN CHAMPIONSHIP U15

Niksic (MNE), 07-08 Jul 2018

-36 kg

8 Judoka

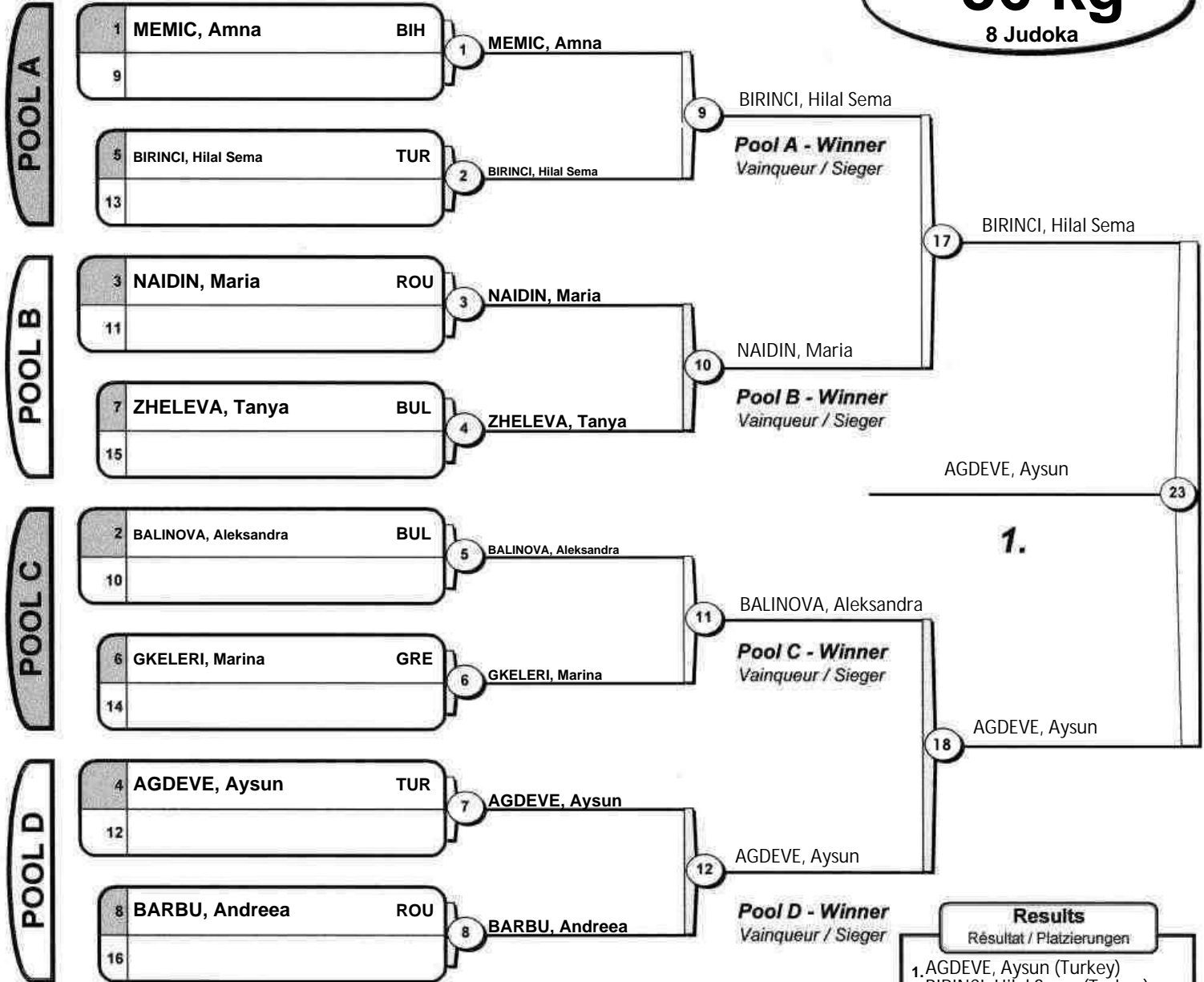

Results

Résultat / Platzierungen

1. AGDEVE, Aysun (Turkey)
2. BIRINCI, Hilal Sema (Turkey)
3. BALINOVA, Aleksandra (Bulgaria)
3. BARBU, Andreea (Romania)
5. ZHELEVA, Tanya (Bulgaria)
5. NAIDIN, Maria (Romania)
7. MEMIC, Amna (BiH)
7. GKELERI, Marina (Greece)

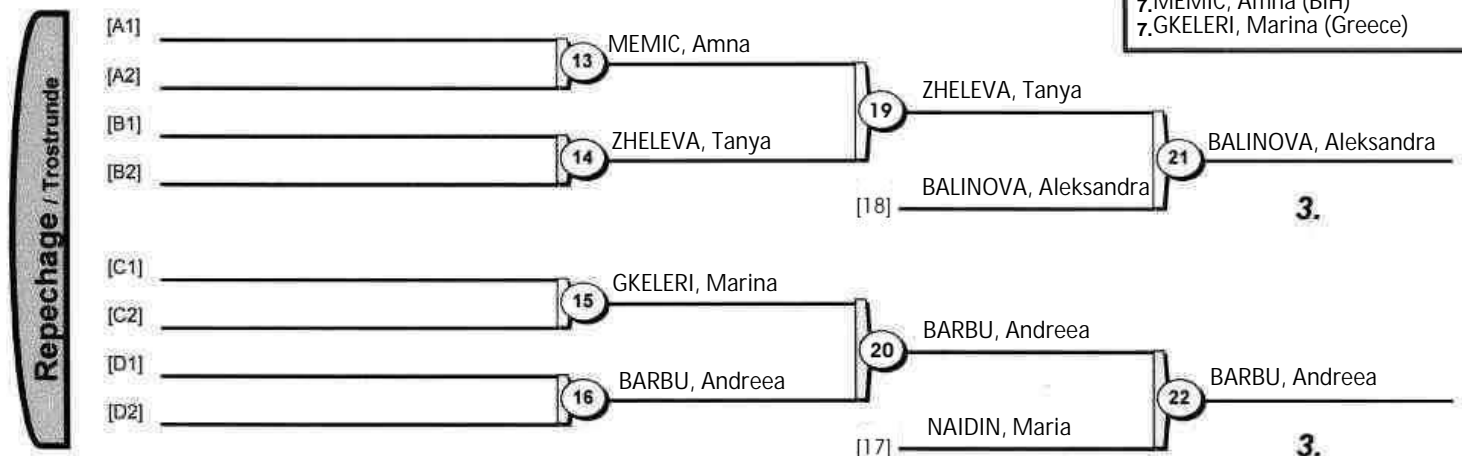

BALKAN CHAMPIONSHIP U15

Niksic (MNE), 07-08 Jul 2018

-40 kg

8 Judoka

POOL A

1 STOYANOVA, Viktoria BUL
9

1 STOYANOVA, Viktoria

5 BULUT, Nurgun TUR
13

2 BULUT, Nurgun

9 BULUT, Nurgun
Pool A - Winner
Vainqueur / Sieger

POOL B

3 ZADRO, Monika BIH
11

3 ZADRO, Monika

7 POPOVICI, Ana ROU
15

4 POPOVICI, Ana

10 POPOVICI, Ana
Pool B - Winner
Vainqueur / Sieger

POOL C

2 MOLDOVEANU, Iulia ROU
10

5 MOLDOVEANU, Iulia

6 MESKA, Anna GRE
14

6 MESKA, Anna

11 MOLDOVEANU, Iulia
Pool C - Winner
Vainqueur / Sieger

POOL D

4 MILADIN, Sara BIH
12

7 MILADIN, Sara

8 OZTURK, Kardelen TUR
16

8 OZTURK, Kardelen

12 OZTURK, Kardelen
Pool D - Winner
Vainqueur / Sieger

17 BULUT, Nurgun

23 BULUT, Nurgun

1.

18 MOLDOVEANU, Iulia

Results
Résultat / Platzierungen

1. BULUT, Nurgun (Turkey)
2. MOLDOVEANU, Iulia (Romania)
3. OZTURK, Kardelen (Turkey)
3. POPOVICI, Ana (Romania)
5. STOYANOVA, Viktoria (Bulgaria)
5. MILADIN, Sara (BiH)
7. ZADRO, Monika (BiH)
7. MESKA, Anna (Greece)

Repechage / Trostrunde

[A1] STOJANOVA, Victoria

[A2] 13 STOJANOVA, Victoria

[B1] ZADRO, Monika

[B2] 14 ZADRO, Monika

19 STOJANOVA, Victoria

[18] OZTURK, Kardelen

21 OZTURK, Kardelen

3.

[C1] MESKA, Anna

[C2] 15 MESKA, Anna

[D1] MILADIN, Sara

[D2] 16 MILADIN, Sara

20 MILADIN, Sara

[17] POPOVICI, Ana

22 POPOVICI, Ana

3.

BALKAN CHAMPIONSHIP U15

Niksic (MNE), 07-08 Jul 2018

-44 kg

10 Judoka

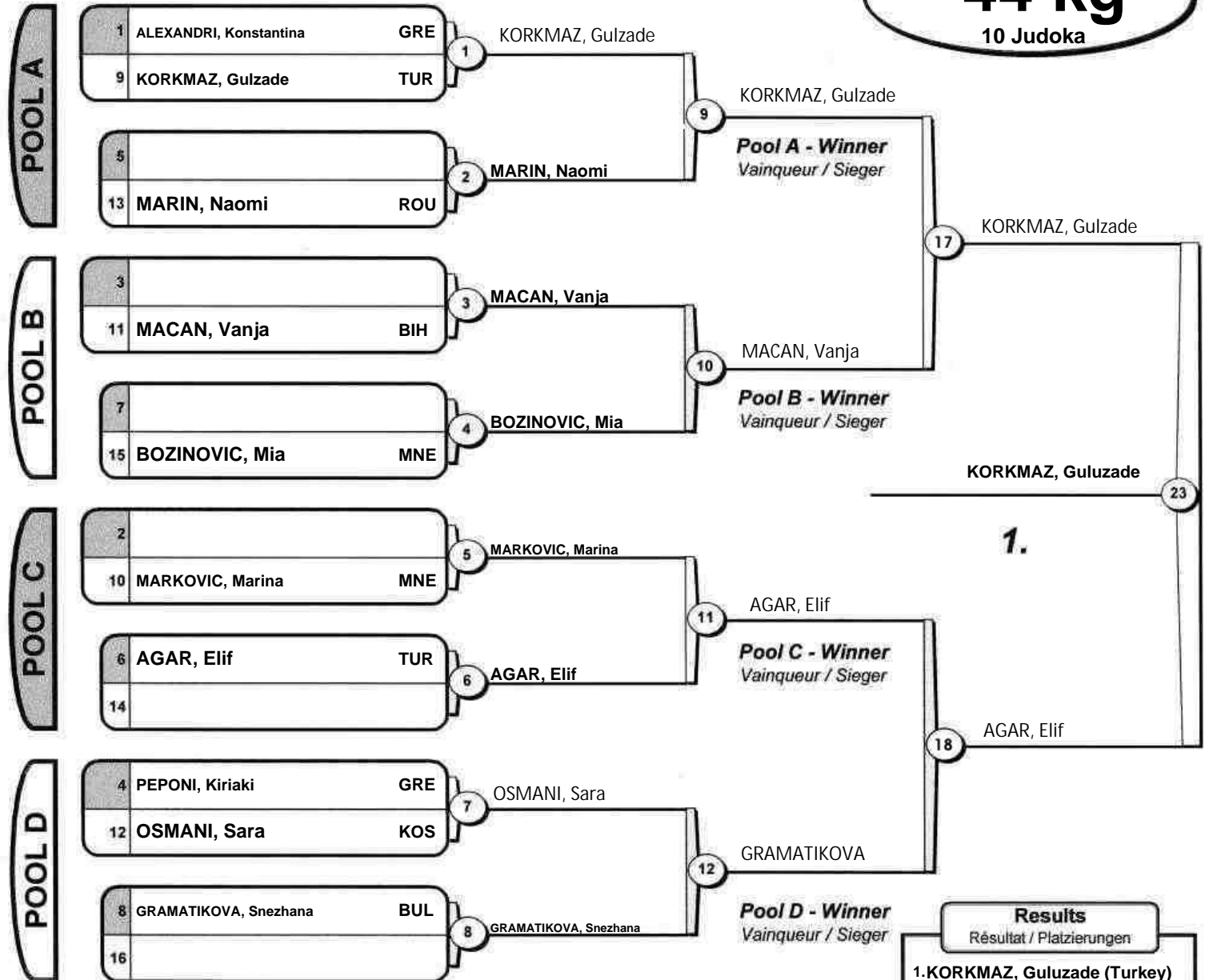

Results

Résultat / Platzierungen

1. KORKMAZ, Gulzade (Turkey)
2. AGAR, Elif (Turkey)
3. MARIN, Naomi (Romania)
3. MARKOVIC, Marina (Montenegro)
5. GRAMATIKOVA, Snezhana (Bulgaria)
5. MACAN, Vanja (BiH)
7. BOZINOVIC, Mia (Montenegro)
7. OSMANI, Sara (Kosovo)

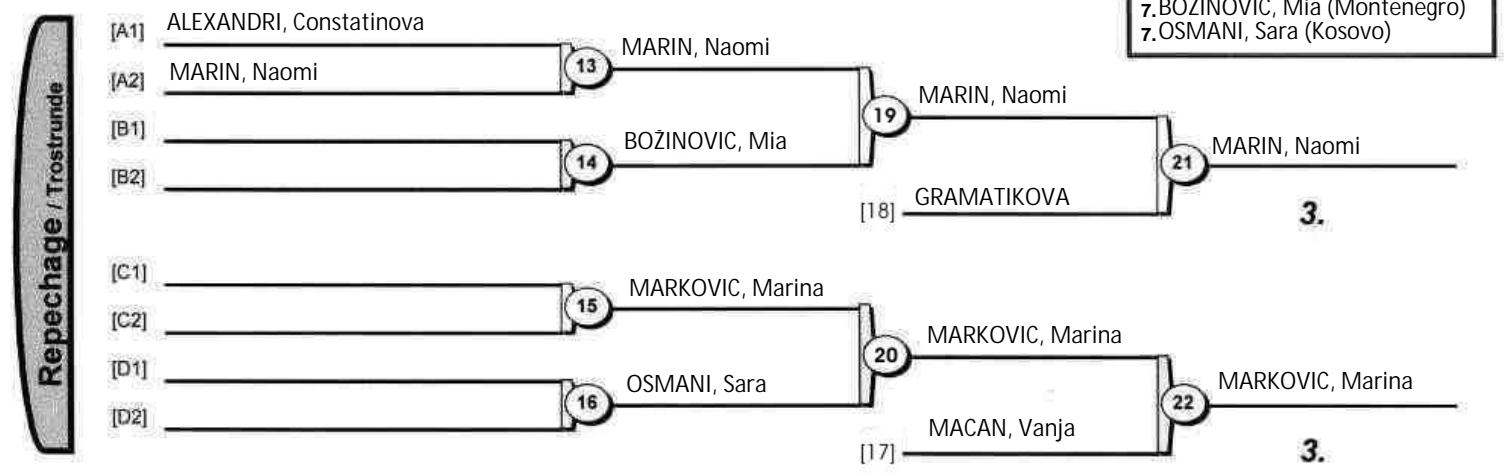

BALKAN CHAMPIONSHIP U15

Niksic (MNE), 07-08 Jul 2018

-48 kg

15 Judoka

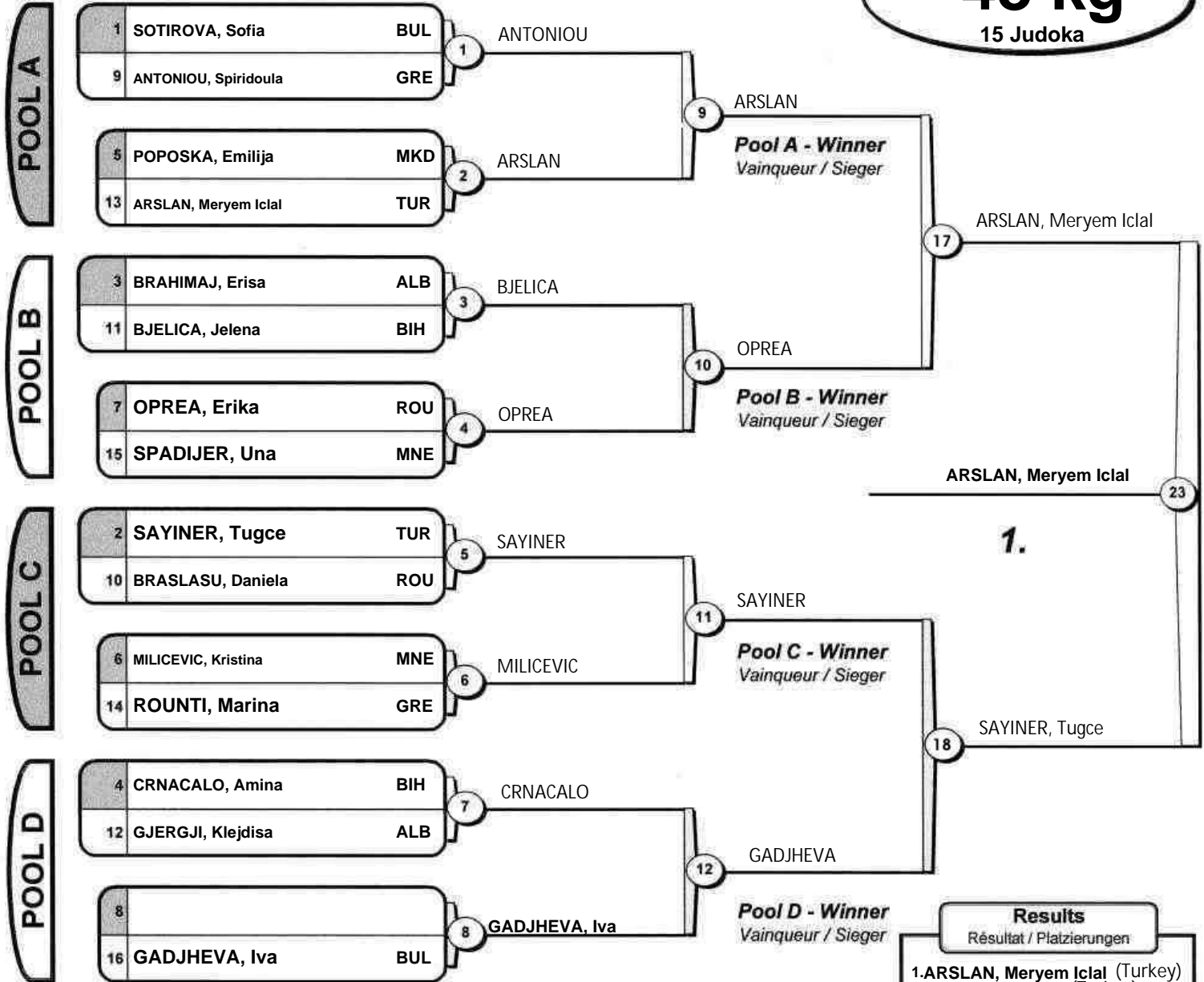

Results	
Résultat / Platzierungen	
1.	ARSLAN, Meryem Iclal (Turkey)
2.	SAYINER, Tugce (Turkey)
3.	SPADIJER, Una (Montenegro)
3.	MILICEVIC, Kristina (Montenegro)
5.	GADJHEVA, Iva (Bulgaria)
5.	OPREA, Erika (Romania)
7.	POPOSKA, Emilija (Macedonia)
7.	CRNCALO, Amina (BiH)

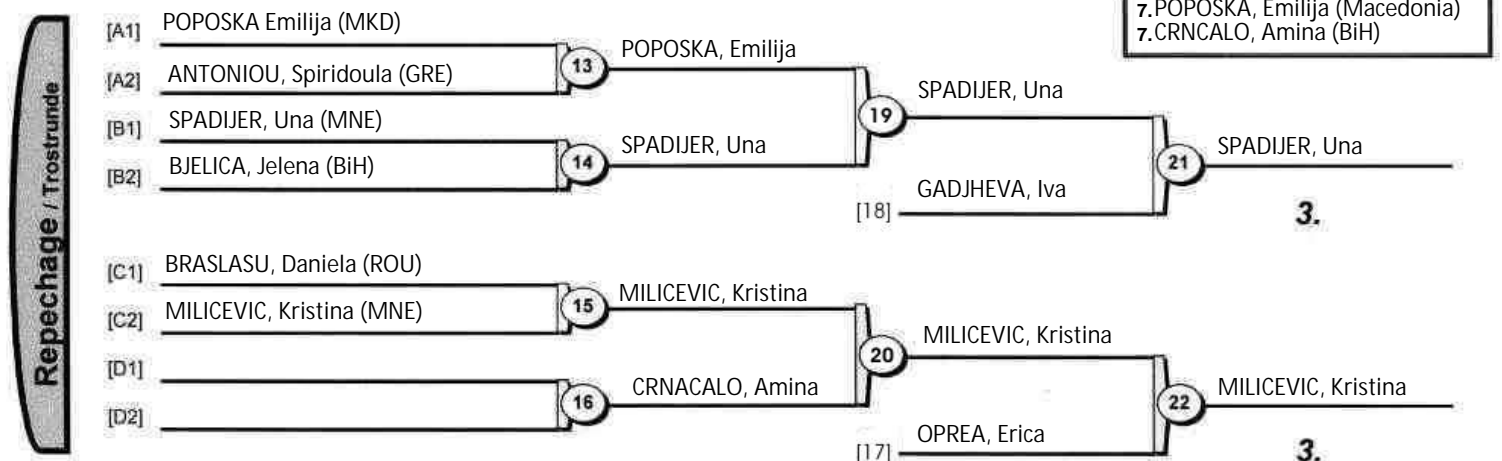

BALKAN CHAMPIONSHIP U15

Niksic (MNE), 07-08 Jul 2018

-52 kg

13 Judoka

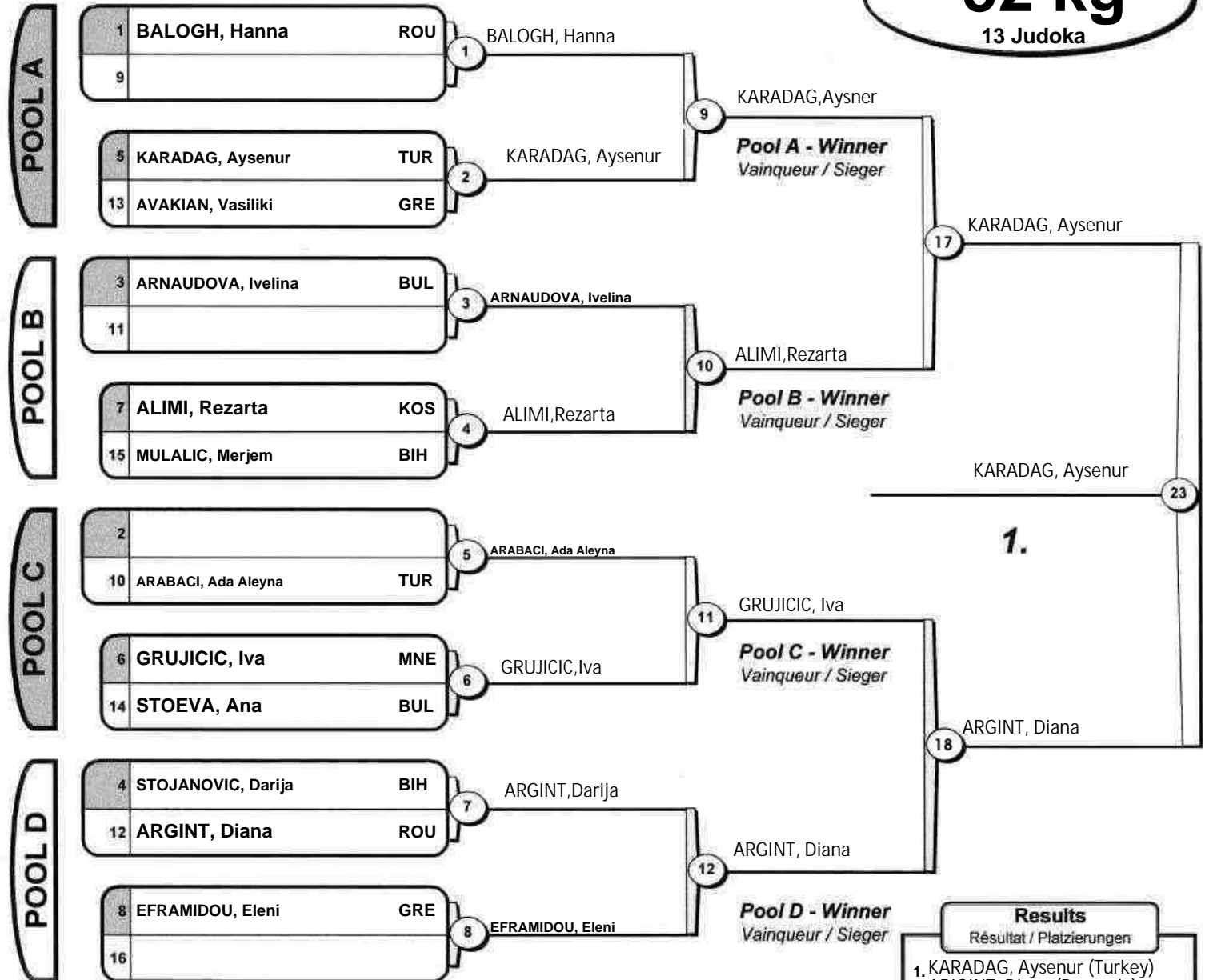

Results	
Résultat / Platzierungen	
1.	KARADAG, Aysnur (Turkey)
2.	ARGINT, Diana (Romania)
3.	MULALIC, Merjem (BIH)
3.	STOJANOVIC, Darija (BIH)
5.	GRUJICIC, Iva (Montengro)
5.	ALIMI, Rezarta (Kosovo)
7.	AVAKIAN, Vasiliki (GRE)
7.	ARABACI, Ada Aleyna (TUR)

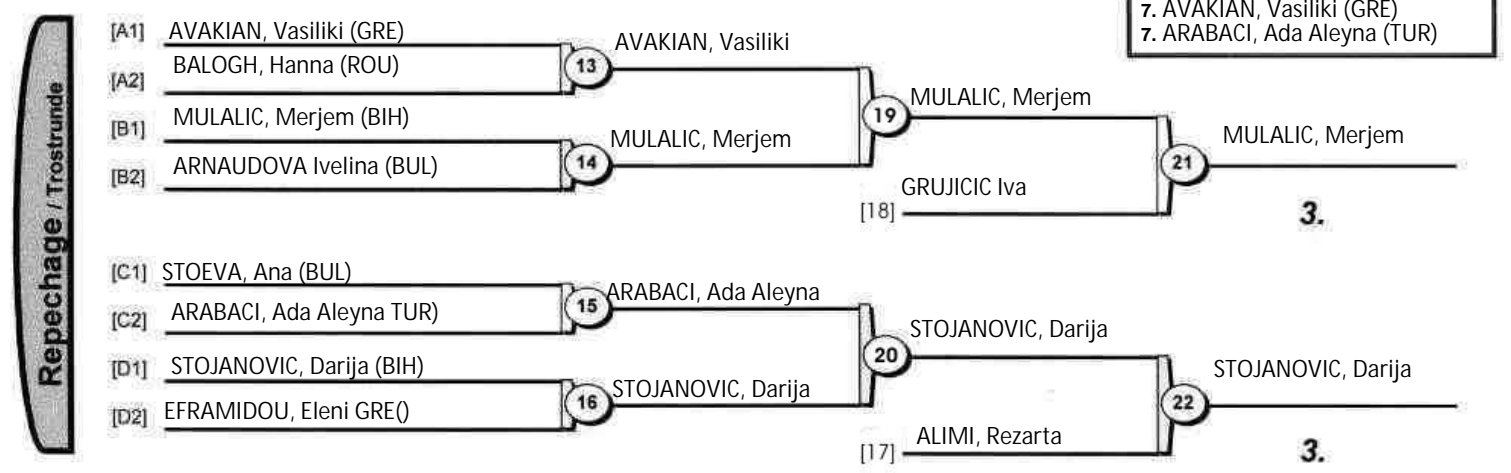

BALKAN CHAMPIONSHIP U15

Niksic (MNE), 07-08 Jul 2018

-57 kg

13 Judoka

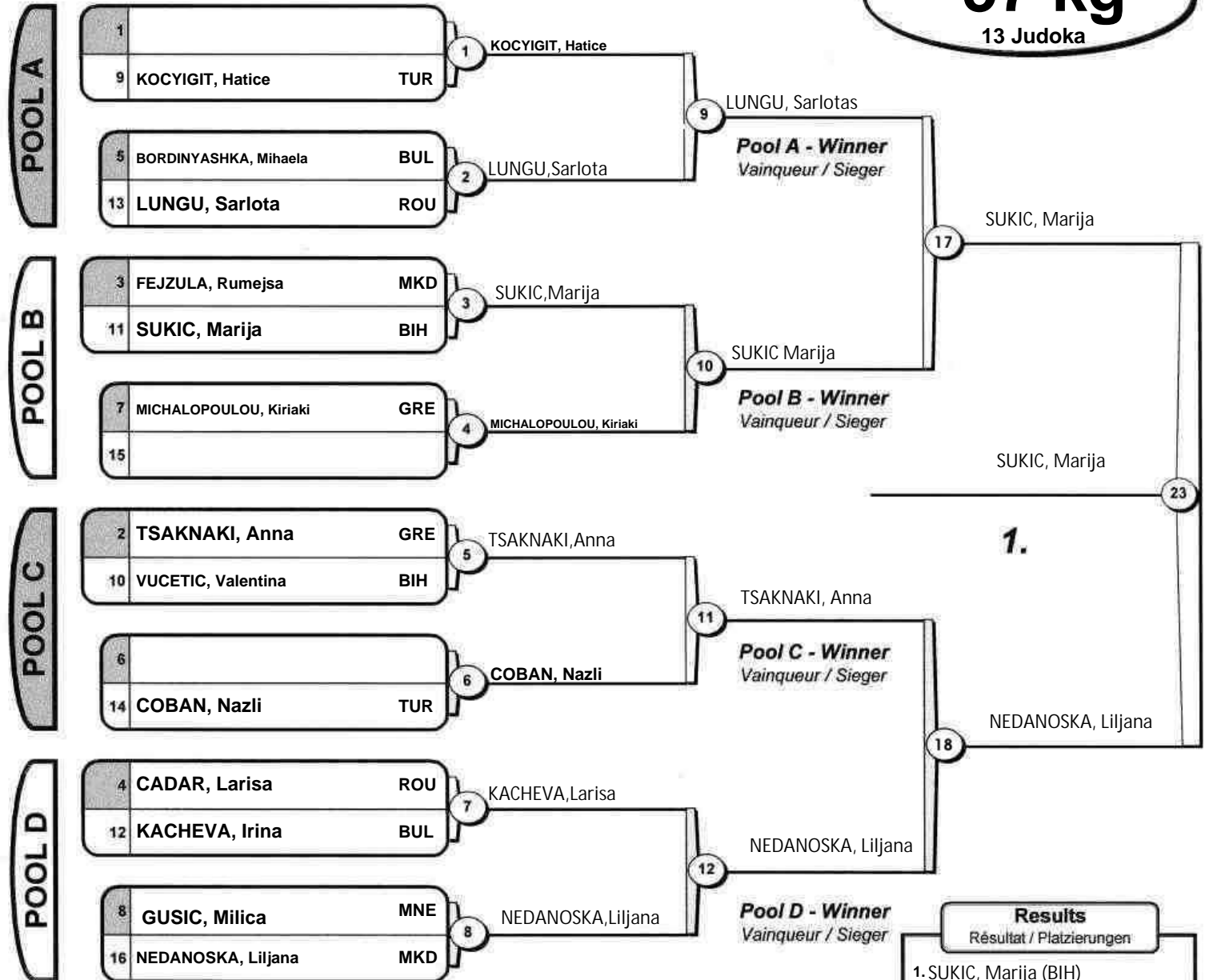

- Results**
Résultat / Platzierungen
- SUKIC, Marija (BIH)
 - NEDANOSKA, Liljana (MKD)
 - KOCYIGIT, Hatice (TUR)
 - LUNGU, Sarlota (Romania)
 - TSAKNAKI, Anna (Greece)
 - KACHEVA, Irina (Bulgaria)
 - MICHALOPOULOU, Kiriaki (GRE)
 - COBAN, Nazli (Turkey)

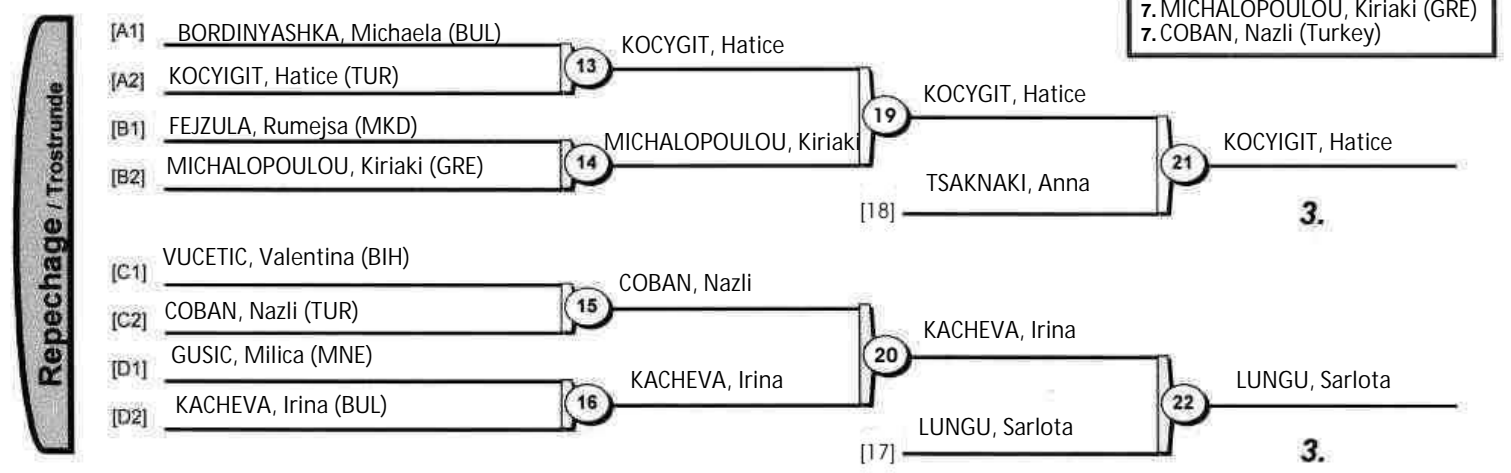

BALKAN CHAMPIONSHIP U15

Niksic (MNE), 07-08 Jul 2018

-63 kg

11 Judoka

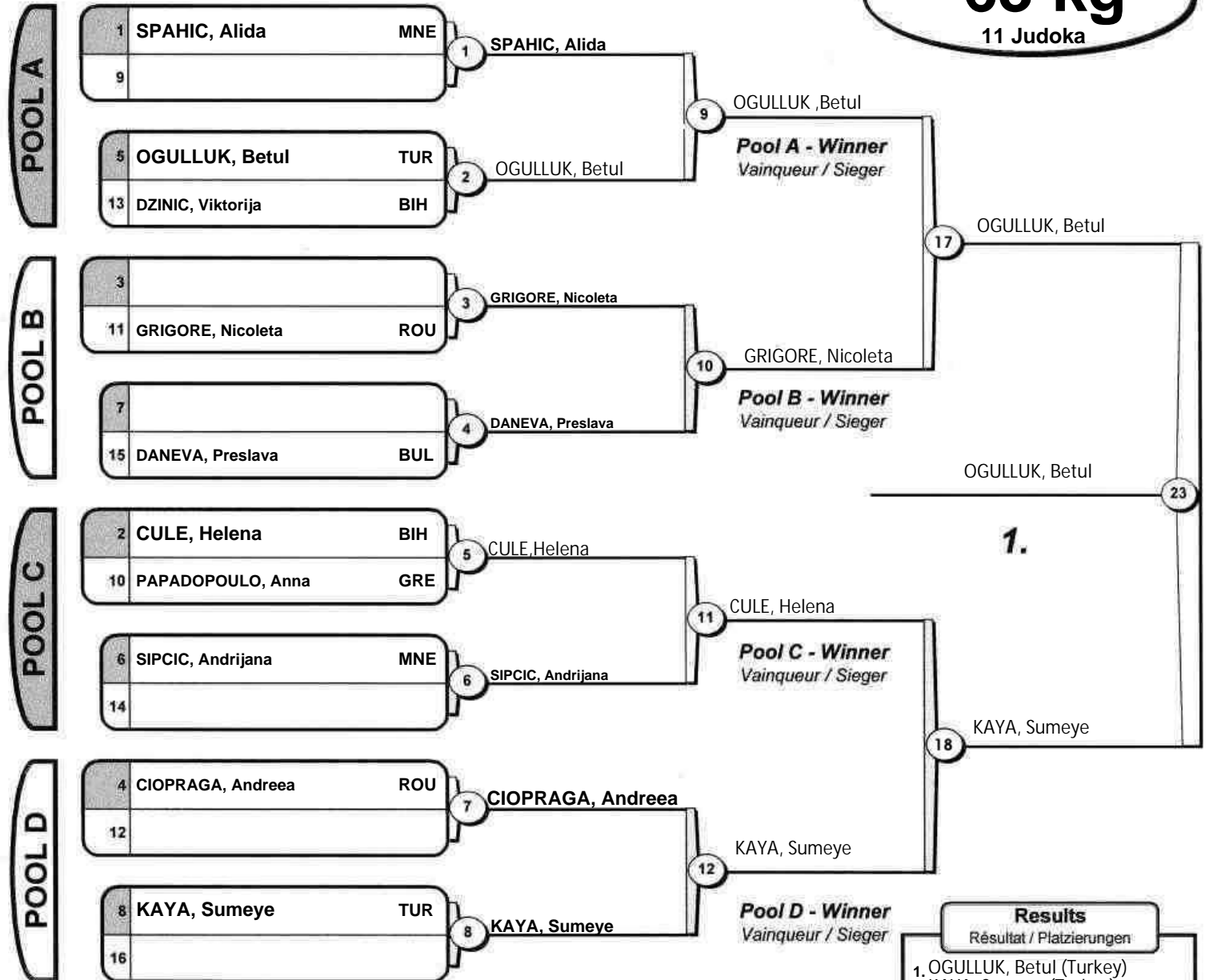

Results	
Résultat / Platzierungen	
1.	OGULLUK, Betul (Turkey)
2.	KAYA, Sumeye (Turkey)
3.	DZINIC, Viktorija (BIH)
3.	GRIGORE, Nicoleta (Romania)
5.	CULE, Helena (BIH)
5.	CIORAGA, Andrea (Romania)
7.	DANEVA, Preslava (Bulgaria)
7.	PAPADOPOULO, Anna (GRE)

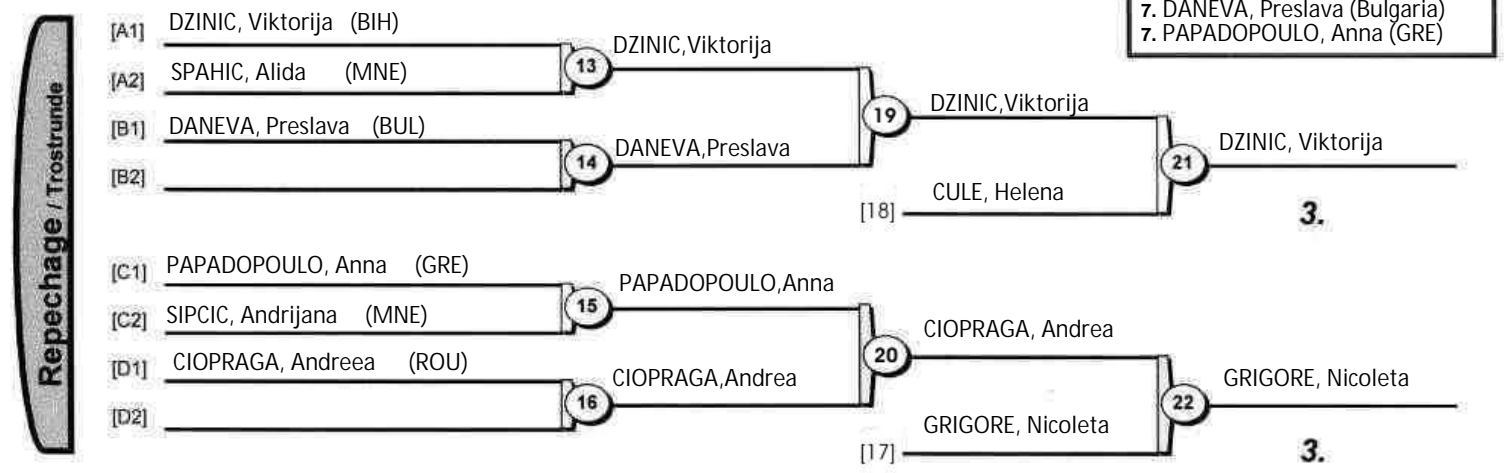

BALKAN CHAMPIONSHIP U15

Niksic (MNE), 07-08 Jul 2018

+63 kg

11 Judoka

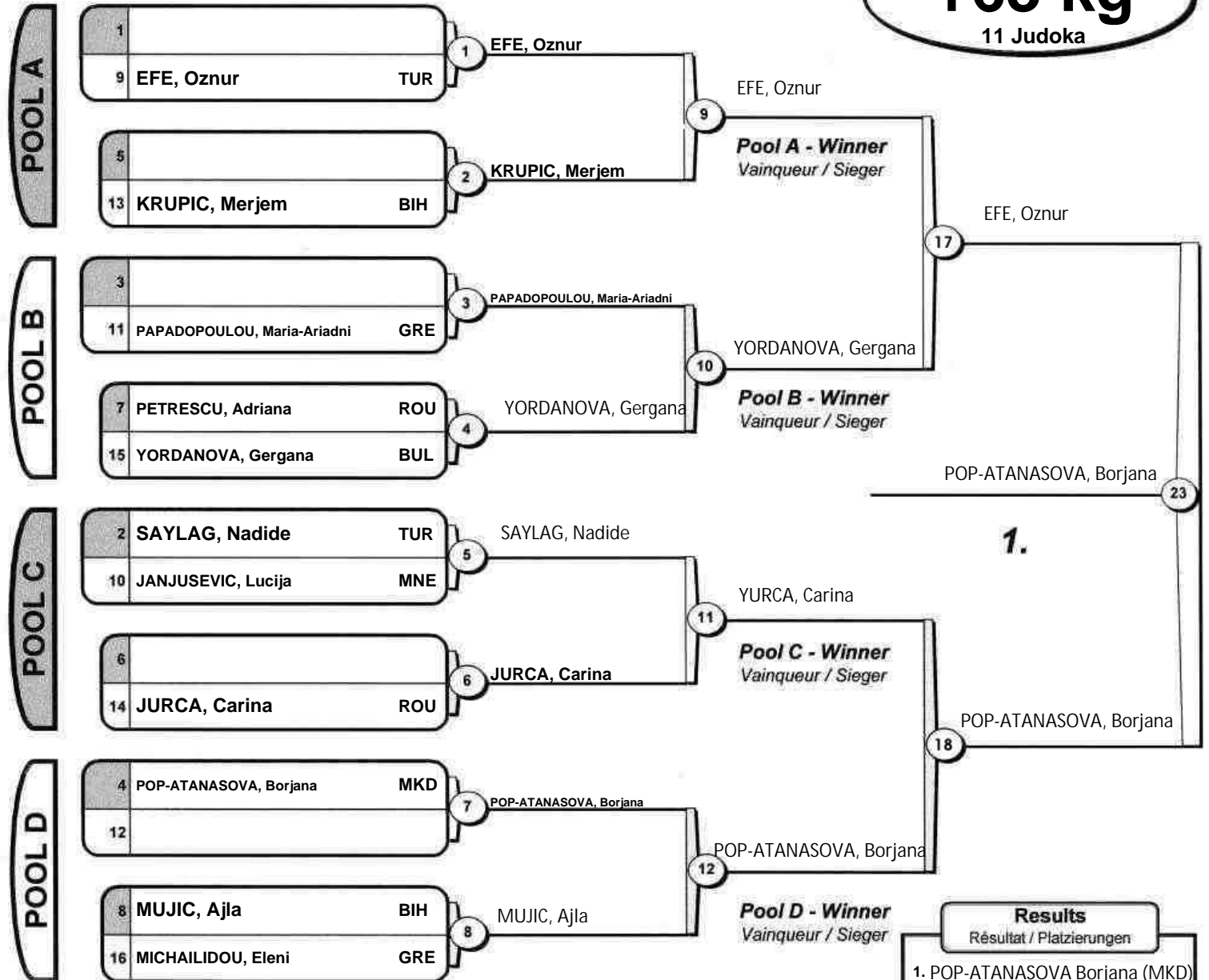

Results	
Résultat / Platzierungen	
1.	POP-ATANASOVA Borjana (MKD)
2.	EFE, Oznur (Turkey)
3.	JURCA, Carina (Romania)
3.	SAYLAG, Nahide (Turkey)
5.	PETRESCU, Adriana (Romania)
5.	YORDANOVA, Gergana (BUL)
7.	KRUPIC, Merjem (BIH)
7.	MUJIC, Ajla (BIH)

